

S41i CO₂ Incubator Shaker

Operating manual

Copyright

Copyright © 2015 Eppendorf AG, Germany. No part of this publication may be reproduced without the prior permission of the copyright owner.

The company reserves the right to change information in this document without notice. Updates to information in this document reflect our commitment to continuing product development and improvement.

Trademarks

Eppendorf® and the Eppendorf Logo are registered Trademarks of Eppendorf AG, Germany

New Brunswick™ is a registered trademark of Eppendorf, AG, Germany.

BioCommand® is a registered trademark of Eppendorf AG, Germany.

Trademarks are not marked in all cases with ™ or ® in this manual.

Eppendorf has attempted to identify the ownership of all trademarks from public records. Any omissions or errors are unintentional.

Table of contents

1	Operating instructions	7
1.1	Using this manual	7
1.2	Danger symbols and danger levels	7
1.2.1	Hazard symbols	7
1.2.2	Degrees of danger	7
1.3	Symbols used	8
1.4	Abbreviations used	8
2	Safety	9
2.1	Intended use	9
2.2	Application limits	9
2.2.1	Description of ATEX Guideline (94/9EC)	9
2.3	Information on Product Liability	10
2.4	Warnings for intended use	10
2.4.1	Personal injury and damage to device	10
3	Product description	13
3.1	Main illustration	13
3.2	Delivery Package	14
3.3	Features	14
3.4	High temperature disinfection	15
4	Installation	17
4.1	Inspection of Boxes	17
4.2	Unpacking	17
4.3	Utilities Requirements	18
4.4	Location	18
4.5	Installation of Foot Shields	19
4.6	Platform Assemblies	21
4.7	Installation of Platform	22
4.8	Flask Clamp Installation	22
4.9	Stacking Instructions	24
4.10	Electrical Connections	24
4.11	Setting Up	25
4.12	Making Connections	26
4.13	Ethernet Connection	29
4.14	BMS relay contact alarm	29
5	Operation	31
5.1	Preparing for Operation	31
5.2	Using the Humidity Trays	31
5.3	Starting the Incubator Shaker	32
5.4	Using the Touchscreen	32
5.4.1	Initial display and STATUS screen	32
5.4.2	Starting the platform	33
5.4.3	Stopping the platform	34
5.4.4	Setting the temperature	35
5.4.5	Setting the CO ₂ level	36

Table of contents

S41i CO₂ Incubator Shaker
English (EN)

5.4.6	Setting the shaking speed	36
5.5	MENU 1 Screen	37
5.5.1	HELP function	37
5.5.2	EVENT LOG	38
5.5.3	ALARM SETTINGS screen	39
5.5.4	SUMMARY screen	41
5.5.5	EVENT GRAPH screen	43
5.5.6	SET CALIBRATION screen	46
5.5.7	GENERAL SETTINGS screen	48
5.5.8	USER ACCESS screen	54
5.5.9	COMMUNICATIONS screen	58
5.6	MENU 2 Screen	59
5.6.1	SERVICE screen	59
5.6.2	DIAGNOSTICS screen	59
5.6.3	MAINTENANCE screen	60
5.6.4	OPTIONS screen	68
5.6.5	SET CO ₂ AUTOZERO screen	68
5.6.6	DISINFECTION screen	72
5.7	Mains/Power Interruption and Fault Interruption	74
6	Maintenance	75
6.1	Routine Maintenance	75
6.1.1	General notes	75
6.1.2	Daily checks	75
6.1.3	Weekly checks	75
6.1.4	Monthly check	75
6.1.5	Other checks	75
6.1.6	CO ₂ Sampling with Analyzer	76
6.2	Cleaning	76
6.3	Disinfection/Decontamination	76
7	Transport, storage and disposal	79
7.1	Disposal	79
8	Technical data	81
8.1	Weight/dimensions	81
8.1.1	Device Dimensions	81
8.1.2	Platform dimensions	81
8.2	Application Parameters	81
8.2.1	Speed	81
8.2.2	CO ₂ Management	81
8.2.3	Temperature	82
8.2.4	Passive humidity	82
8.2.5	Altitude limit	82
8.3	Power supply	82
9	Ordering information	83
9.1	Accessories	83

Index 86

Certificates 87

Table of contents

S41i CO₂ Incubator Shaker
English (EN)









1 Operating instructions

1.1 Using this manual

- ▶ Carefully read this operating manual before using the device for the first time.
- ▶ Also observe the operating manual enclosed with the accessories.
- ▶ The operating manual should be considered as part of the product and stored in a location that is easily accessible.
- ▶ When passing the device on to third parties, be sure to include this operating manual.
- ▶ If this manual is lost, please request another one. The current version can be found on our website www.eppendorf.com.

1.2 Danger symbols and danger levels

1.2.1 Hazard symbols

	Hazard point		Burns
	Electric shock		Material damage
	Explosion		Heavy loads
	Inhalation		Crush

1.2.2 Degrees of danger

The following degree levels are used in safety messages throughout this manual. Acquaint yourself with each item and the potential risk if you disregard the safety message.

DANGER	<i>Will</i> lead to severe injuries or death.
WARNING	<i>May</i> lead to severe injuries or death.
CAUTION	May lead to light to moderate injuries.
NOTICE	May lead to material damage.

1.3 Symbols used

Example	Meaning
▶	You are requested to perform an action.
1. 2.	Perform these actions in the sequence described.
•	List.
	References useful information.

1.4 Abbreviations used

kWh

Kilowatt hours

LEL

Lower Explosion Limit

rpm

Revolutions Per Minute

UEL

Upper Explosion Limit

VA

Volt Amps

VAC

Voltage in Alternating Current

2 Safety

2.1 Intended use

The New Brunswick™ S41i incubator shaker provides accurate temperature, CO₂ gas concentrations, and controlled shaking to allow culturing of Eukaryotic cells, as well as aerobic bacteria. A perforated stationary shelf is included to allow simultaneous incubation of adherent cultures. The device is intended for research use only and may be used in laboratories for research, development, and industrial work.

The New Brunswick S41i is exclusively intended for use indoors. Only appropriately qualified personnel are allowed to use New Brunswick S41i. All users must have read the operating manual carefully and familiarized themselves with the operation of the device.

Do not use any heat-generating device inside the chamber of the New Brunswick S41i device.



CAUTION! Lack of safety due to incorrect accessories or spare parts

Accessories and spare parts that are not recommended by Eppendorf compromise the safety, function and precision of the device. Eppendorf cannot be held liable or accept any liability for damage resulting from the use of non-recommended accessories and spare parts.

- ▶ Only use accessories and original spare parts recommended by Eppendorf.



When one shelf is installed, the largest flasks that can be contained in this incubator shaker are 1 L Erlenmeyer and 2.8 L Fernbach flasks. Without a shelf, Erlenmeyer flasks up to 4 L can be contained.

2.2 Application limits

2.2.1 Description of ATEX Guideline (94/9EC)



DANGER! Explosion hazard

- ▶ Do not operate the device in areas where work is completed with explosive substances.
- ▶ Do not use this device to process any explosive or highly reactive substances.
- ▶ Do not use this device to process any substances which could create an explosive atmosphere.



CAUTION! Lack of safety due to incorrect use of materials

- ▶ Do not use this device to process any flammable materials, or use materials where the transfer of mechanical energy to glass apparatus could lead to breakage.

Due to its design and the ambient conditions in its interior, the device is not suitable for use in potentially explosive atmospheres.

SafetyS41i CO₂ Incubator Shaker

English (EN)

The device may only be used in a safe environment, e.g., the open atmosphere of a ventilated lab.

The use of substances which may contribute to a potentially explosive atmosphere is not permitted.

The final decision regarding the risks associated with using these types of substances is the user's responsibility.

2.3 Information on Product Liability

In the following cases, the designated protection of the device may be compromised.

The liability for the function of the device passes to the operator if:

- The device is not used in accordance with this operating manual.
- The device is used outside of the range of application described in the succeeding chapters.
- The device is used with accessories or consumables that were not approved by Eppendorf.
- Service or maintenance is completed on the device by people who are not authorized by Eppendorf.
- The owner has made unauthorized modifications to the device.

2.4 Warnings for intended use

Before using the incubator shaker, read the operating manual and observe the following general safety instructions.

2.4.1 Personal injury and damage to device

**WARNING! Risk of personal injury**

Burns due to hot surface.

- ▶ Do not touch the incubator shaker during the high temperature disinfection cycle.
- ▶ Do not open incubator shaker door during the cycle.

**CAUTION! Risk of personal injury**

- ▶ A mechanical lifting device is required to safely lift the incubator shaker.

**NOTICE! Risk of material damage**

- ▶ Never try to lift the incubator shaker by its door; this would cause permanent damage to the incubator shaker.
- ▶ Never lean on or place objects on the open door.



NOTICE! Risk of material damage

- ▶ To avoid possible damage to the CO₂ sensor, never leave water in the humidity trays while the incubator shaker is switched off, or when a high temperature disinfection cycle is initiated.
-

Safety

S41i CO₂ Incubator Shaker
English (EN)

3 Product description

3.1 Main illustration

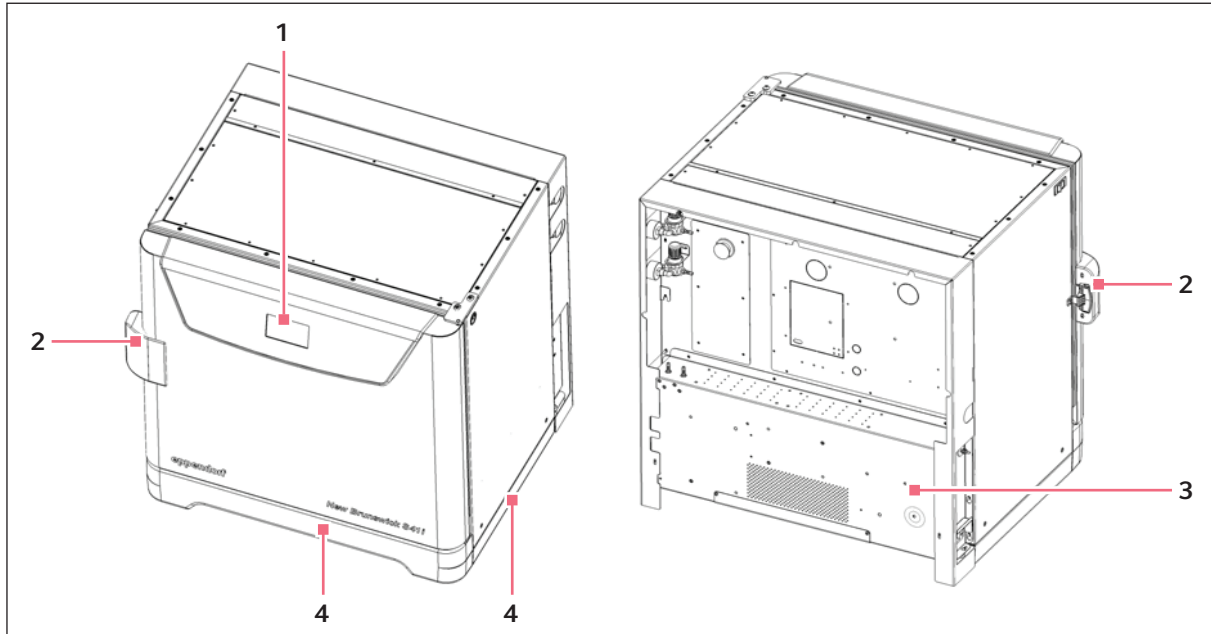

Fig. 3-1: Front and rear views

1 Display

2 Door handle

3 Control box

4 Foot shield

Product descriptionS41i CO₂ Incubator Shaker

English (EN)

3.2 Delivery Package



The operating manual and mains/power cord are shipped on top of the control box at the rear of the incubator shaker.

Quantity	Item	Notes
1	Perforated Stainless Steel Shelf	Installed
1	White porous CO ₂ Sensor Cover	
1	Black Sensor Cover	
1	Front foot shield	Packed on top of incubator shaker
2	Side foot shields	
2	Humidity Trays	Packed in box on shelf
3 m (9.8 ft)	PVC Tubing, ~6 mm (1/4 in) bore, with an inline CO ₂ HEPA-filter connected, ready for use	Packed in box on shelf
2	Hose Clips	Packed in humidity tray
1	Auto-zero HEPA Filter	
1	BMS connector	Packed in accessories bag
3	Rack spacers	
3	Rack feet	
2	Additional white porous CO ₂ sensor cover	
1	Mains/Power Cord	Packed on top of control box at rear of incubator shaker
1	Operating Manual	

3.3 Features

The chamber's fanless design with six-sided convection heating provides gentle circulation and uniform temperature. In addition, the seamless one-piece chamber eliminates area where contaminants could collect and makes wipe-down easy.

Two humidity trays reduce sample evaporation.

The New Brunswick S41i fits on the floor, on the floor under a workbench or it can be double stacked to save space. The shaking mechanism is a heavy-duty drive with three eccentric drive shafts to provide stability, uniform motion and assure long incubator shaker life. The orbit is 2.5 cm (1 in) and the shaking speed range is from 25 - 400 rpm (± 1 rpm), unless two are stacked, in which case the maximum speed of the top incubator shaker is limited to 250 rpm.

With no shelf present, flasks up to 4 L in size can be installed on the shaking platform. With one stationary shelf present, Erlenmeyer flasks up to 1 L can be installed. If two shelves are present, Erlenmeyer flasks, because of their tall necks, must be limited to 250 mL.

The temperature range is from 4 °C above ambient temperature to 50 °C. Temperature accuracy is ± 0.2 °C through the entire range.

CO₂ control ranges from 0.2 to 20 %, with an accuracy of ± 0.1 % at 20 % CO₂ via the InfraRed CO₂ sensor.

3.4 High temperature disinfection

The High Temperature Disinfection cycle on the New Brunswick S41i is designed to heat the internal chamber to 120 °C, maintain that temperature for 3.5 hours, and then allow the chamber to cool down to 37 °C or to the programmed temperature (if different from 37 °C) and the normal control will take over. The cool down to normal operating temperature will take approximately 11 hours. The total time for the HTD cycle to complete will be 14 – 15 hours dependent on the ambient conditions.

The HTD cycle is designed to disinfect all internal surfaces and components. The cycle is initiated from the touch screen display and is accessed on the Menu 2 screen; press the disinfection icon and the screen will prompt the user how to proceed (see *DISINFECT* screen on p. 72). Once the disinfection is complete the screen will alert the user; if the disinfection procedure is cancelled the screen will alert the user that this has occurred.

The event graph will track the cycle and show temperature and time and provide a visual indication that the cycle took place and was completed (see *EVENT GRAPH* screen on p. 43).

Product description

S41i CO₂ Incubator Shaker
English (EN)

4 Installation

4.1 Inspection of Boxes

After you have received your order, inspect the boxes carefully for any damage that may have occurred during shipping. Report any damage to the carrier and to your local Eppendorf distributor immediately.

4.2 Unpacking



CAUTION! Risk of personal injury

- ▶ A mechanical lifting device is required to safely lift the incubator shaker.



NOTICE! Risk of material damage

- ▶ Never try to lift the incubator shaker by its door; this would cause permanent damage to the incubator shaker.
- ▶ Never lean on or place objects on the open door.



CAUTION! Lack of safety due to humid storage and transport conditions

- ▶ Unit needs to be evaluated for condensation when received and unpacked for installation.
- ▶ If condensation due to storage and transport in humid conditions has occurred, please allow for a 4 hour drying-out time in an environment of 18 °C – 25 °C, and 30 % – 80 % relative humidity. Without this drying-out process, the unit cannot be assumed to meet safety requirements.

-
- ▶ Save the packing materials for possible future use, and be sure to save this Operating Manual for instruction and reference. User manuals can also be found online, in PDF format, at newbrunswick.eppendorf.com.
 - ▶ Save the foot shields packed on top of the incubator shaker, which you will install.
 - ▶ Use a mechanical lifting device to safely lift the incubator shaker off its shipping pallet and to transport it to the installation site (see *Location* on p. 18). For incubator shaker weight: (see *Weight/dimensions* on p. 81). You may push the incubator shaker a short distance using the built-in castors to roll it. To do this, you may need to rotate the incubator shaker feet to raise them so the incubator shaker will rest on its castors.
 - ▶ Remove the sleeved box sitting on the top shelf inside the incubator shaker. As indicated in Delivery package (see *Delivery Package* on p. 14), It contains the two humidity trays, PVC tubing and several other essential parts.
 - ▶ Remove the foam blocks from the top shelf and save them with the other packing materials.
 - ▶ Locate and remove the parts stored in the humidity trays.
 - ▶ Locate and unpack any other components.
 - ▶ If any part of your order was damaged during shipping, is missing, or fails to operate, please contact your Eppendorf distributor.

Installation

S41i CO₂ Incubator Shaker
English (EN)

- ▶ Using your packing list, verify that you have received the correct materials, and that nothing is missing.

4.3 Utilities Requirements

The following utilities requirements are needed for operation:



CO₂ gas pressure to device must exceed 7 PSI (0.5 bar) for optimal operation.

4.4 Location

The incubator shaker is designed to operate at a chamber temperature of 4.0 °C above ambient. If the incubator shaker is being operated at 37 °C, the absolute minimum ambient temperature recommended is 18 °C. **Maximum allowable ambient temperature is 25 °C.**



Position the incubator shaker, allowing enough space to open the door and to access the CO₂ sample port on the right side of the incubator shaker.

Care should be taken to avoid placing the incubator shaker in a position that may affect its performance, such as those listed below.

DO NOT place the incubator shaker:

- Directly under, beside or within the air flow of heating or air-conditioning ducts, or other drafts
- Directly beside heat-generating equipment such as a heater, an autoclave or an oven
- Near the exhaust of heat- or cold-generating equipment (like an ultra-low temperature freezer)
- Near a window exposed to direct sunlight
- Directly on top of any heat-generating apparatus
- Without minimum ventilation clearance of 10 mm (0.5 in) all around



NOTICE! Risk of material damage

- ▶ Never try to lift the incubator shaker by its door; this would cause permanent damage to the incubator shaker.
- ▶ Never lean on or place objects on the open door.

- ▶ Remove the incubator shaker from the pallet as described in Unpacking (see *Unpacking on p. 17*).
- ▶ Place the incubator shaker in the working position, on a level floor capable of bearing its weight. You may need to rotate the incubator shaker feet to raise them, in order to rest the incubator shaker on its castors to be moved more easily (see Fig. 4-1 on p. 19).

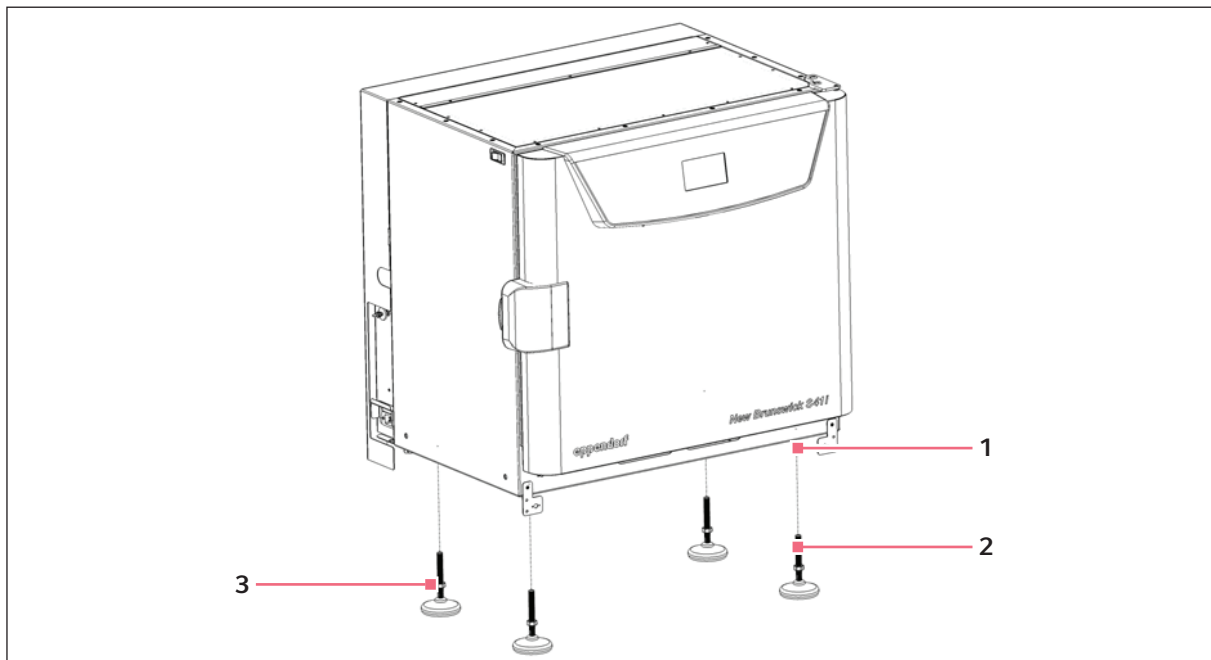

Fig. 4-1: Adjustable feet

1 Castors located in all four corners

3 Lock nut

2 Adjustable foot

The weight of the incubator shaker is approximately 152 kg (335 lb), but actual in-use weight will naturally be heavier and will depend on the material stored in the incubator shaker.

The incubator shaker is designed so that one incubator shaker can be safely stacked on top of another S41i using the optional stacking kit, which includes instructions. It is not possible to put any other type of incubator shaker or heavy apparatus on top, as the top cover and stacking kit are designed to support only the feet of another S41i.

4.5 Installation of Foot Shields

The front and side foot shields (see Fig. 4-2 on p. 20) are packed on top of the incubator shaker, enclosed in bubble wrap. To install them, beginning with the right side foot shield, follow this procedure:

Installation

S41i CO₂ Incubator Shaker
English (EN)

1. Orient the mounting bracket at the front face of the incubator shaker, then align the foot shield's two keyhole slots with the two mounting pins on the bottom of the incubator shaker.

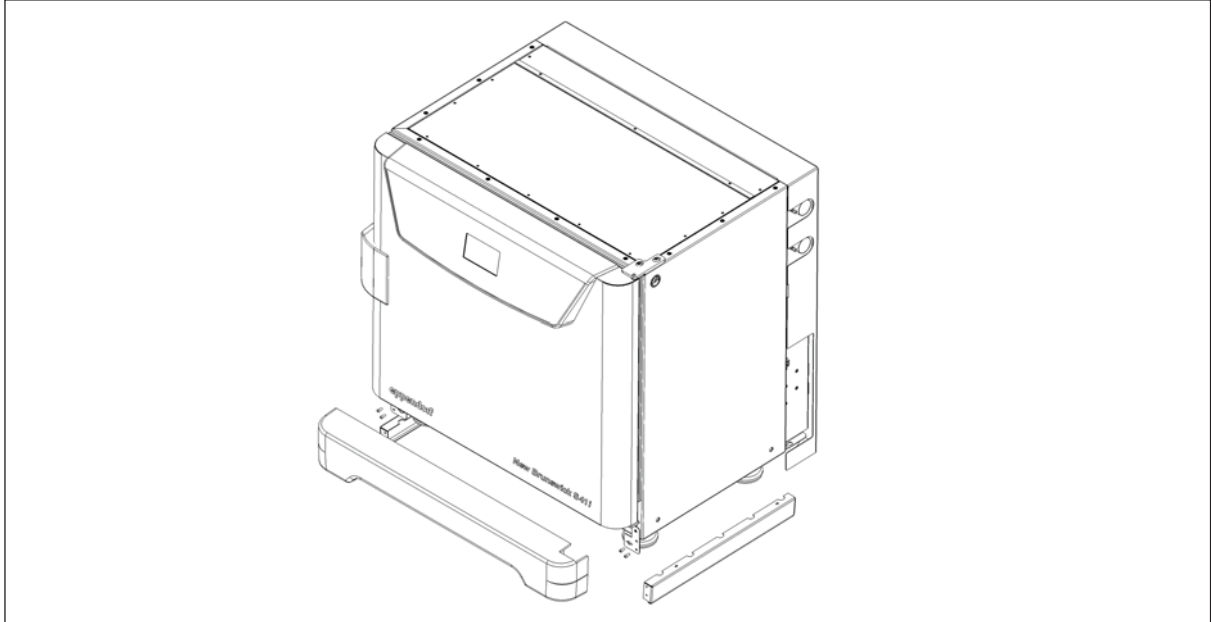

Fig. 4-2: Front and side foot shields

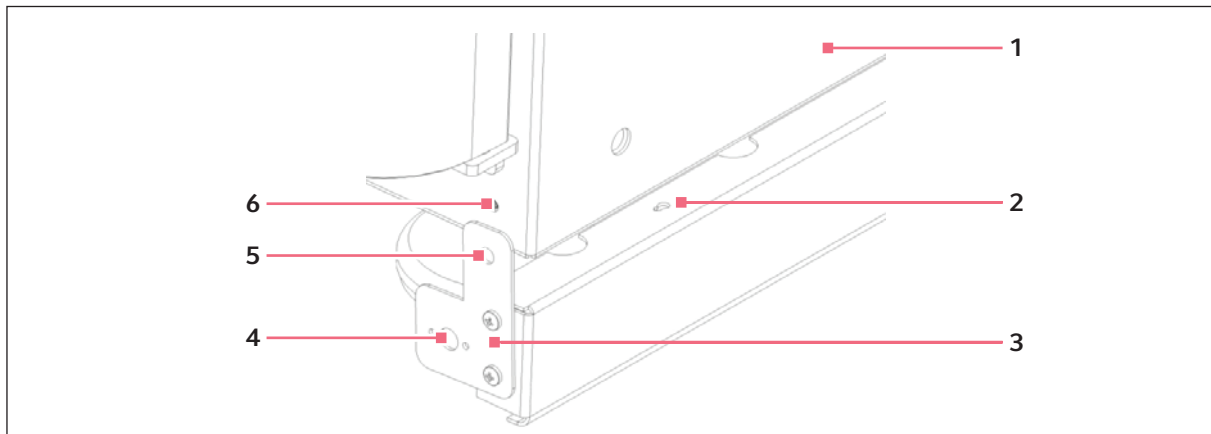

Fig. 4-3: Side foot shield installation

- | | |
|---|--|
| 1 Right side of incubator shaker | 4 Hole for front foot shield's ball catch |
| 2 Keyhole slot on right side foot shield | 5 Hole for M4 screw on mounting bracket |
| 3 Mounting bracket | 6 Hole for M4 screw on incubator |

2. Snap the side shield in place, then slide it toward the back of the incubator shaker until the bracket is flush against the front face.

3. Fasten the bracket to the incubator shaker with one M4 screw:

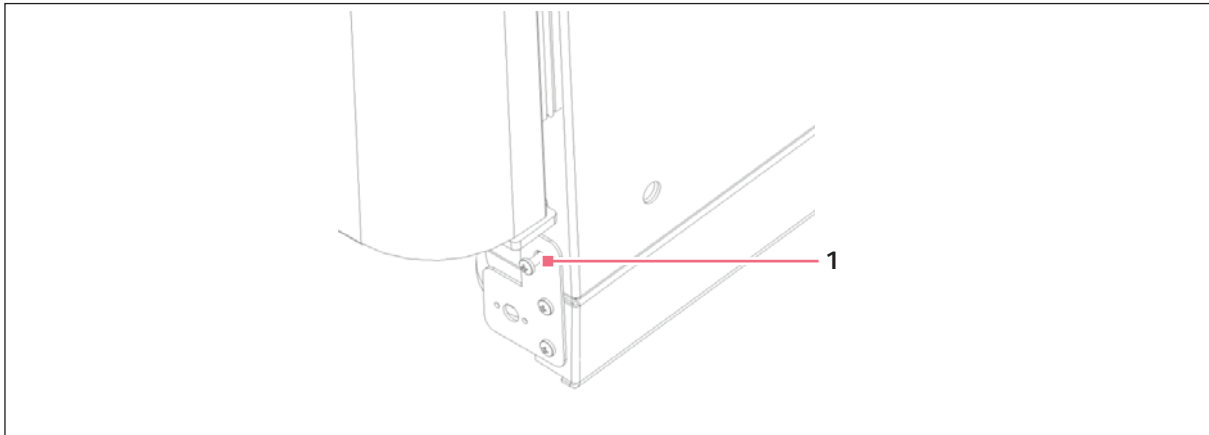

Fig. 4-4: Side foot shield bracket

1 M4 screw inserted here to fasten the side foot shield bracket to the incubator shaker

4. Repeat Steps 1 through 3 for the left side foot shield.
5. Push fit the remaining foot shield onto the bottom front of the incubator shaker. Be sure to align its pins with the holes on the incubator shaker and on the mounting brackets of the side foot shields.

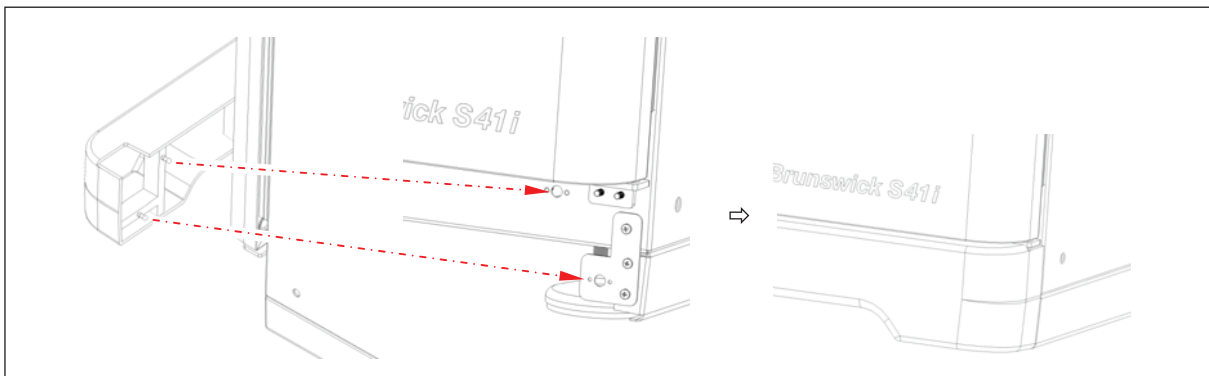

Fig. 4-5: Front foot shield installation

4.6 Platform Assemblies

A platform, which is required for operation, is a separate item, not included with the shaker assembly. The S41i platform, measuring 612 × 356 mm (24 × 14 in), will accept a wide range of clamps for flasks, test tubes, etc.

4.7 Installation of Platform



Prior to use, a platform must be installed on the incubator shaker.

The incubator shaker is shipped with four Allen head platform screws installed in the four bearing housing uprights, as shown below:

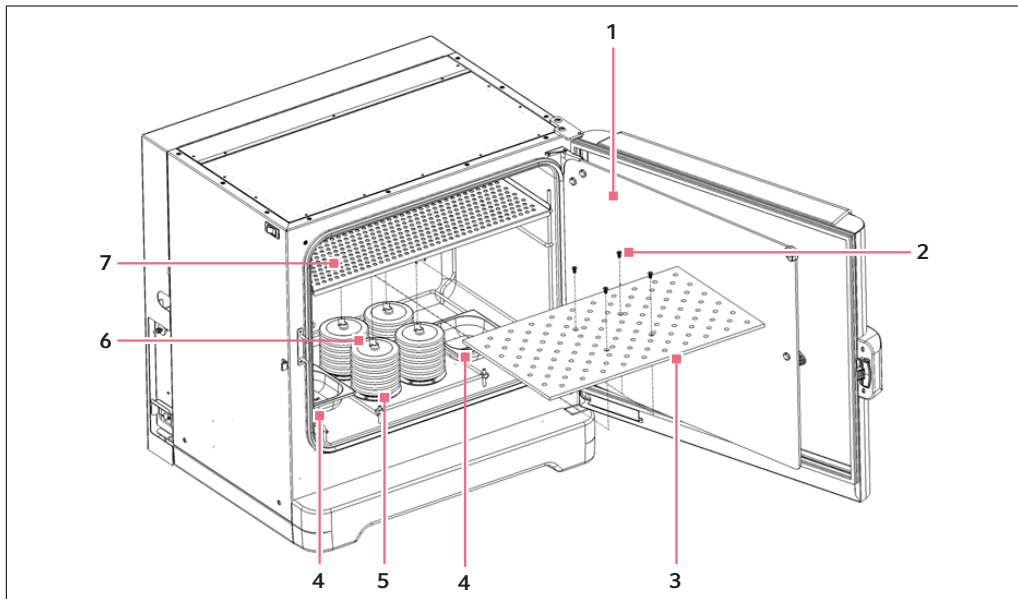



Fig. 4-6: Installing platform

- | | |
|---------------------------|---------------------------------------|
| 1 Glass inner door | 5 Bearing housing |
| 2 Allen screws | 6 Bearing housing uprights |
| 3 Platform | 7 Top shelf, shipped installed |
| 4 Humidity trays | |

1. Set the mains/power to OFF and unplug the incubator shaker.
2. Remove the platform screws, then use them to install the platform over the bearing housing.

4.8 Flask Clamp Installation

Flask clamps purchased for use with the platform require installation. Clamps are installed by securing the base of the clamp to the platform with the correct type and number of screws. All clamps are shipped complete with hardware.

-  The S41i platform requires 10-24 x 5/16-inch Phillips-head screws (which are supplied) to fasten flask clamps.
With one shelf installed, Erlenmeyer flasks larger than 1 L are too tall for the chamber; to use 2 L – 4 L Erlenmeyer flasks, remove the shelf.

Clamps for 2.8-liter Fernbach flasks and 2 L – 4 L Erlenmeyer flasks are shipped with an additional girdle to keep the flasks in place. The girdle is an assembly of springs and sections of rubber tubing. One girdle is already in place on the clamp, the other is packed separately.

To install these double girdle clamps:

1. Place the clamp on the platform, aligning its mounting holes with holes on the platform. Secure the clamp in place using the flat Phillips head screws provided (#S2116-3051, 10-24 x 5/16-inch).



-  Three different types of screws are shipped with the clamps, to identify the proper screws (see Fig. 4-7 on p. 23).

2. With the first girdle in place, as delivered, on the upper part of the clamp body, insert an empty flask into the clamp.
3. After making sure the sections of tubing are located between the clamp legs, roll the first girdle down the legs of the clamp as far as it can go. The tubing sections will rest against the platform, and the springs will be under the clamp base.
4. Place the second girdle around the upper portion of clamp body (just as the first girdle was initially). Make sure that its spring sections rest against the clamp legs, while its rubber tubing sections sit against the flask, in between the clamp legs.



Fig. 4-7: Clamp fastener

Eppendorf line flask clamps are used on a variety of incubator shaker platforms. Flat head screws of different lengths and thread pitch are used to secure the clamp. The following table identifies the proper screw for your incubator shaker application by reference to the head style. Select the appropriate screws and set the others aside.

Description	Part number	Qty	Application
 10-24 x 5/16 (7.9 mm) flat Phillips (+) head screw	S2116-3051	1	5/16" (7.9 mm) thick aluminum, phenolic and stainless steel platforms.  

-  One-liter and larger flask clamps are fastened with 5 screws.

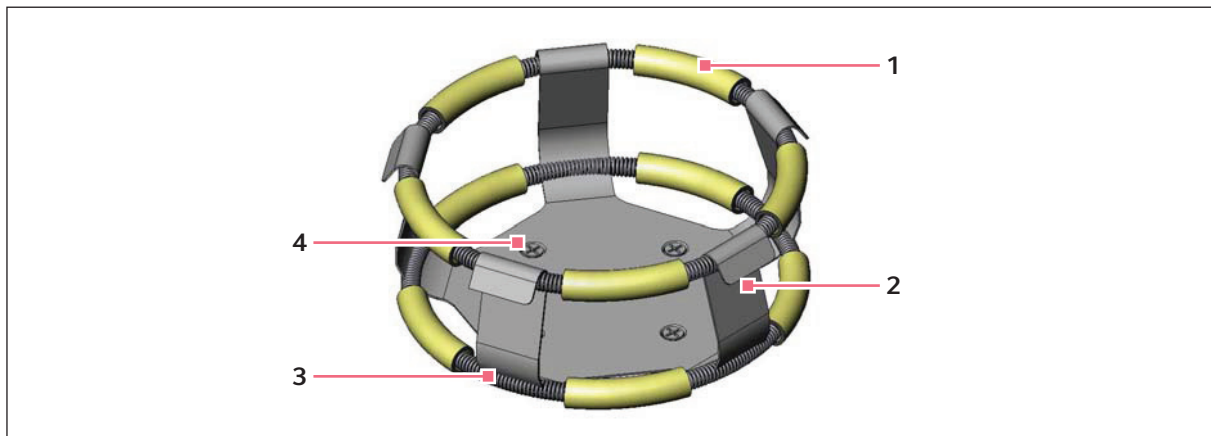

Fig. 4-8: Double girdle clamp installation

- | | |
|---|---|
| 1 Upper girdle with girdle tubes | 3 Lower girdle with girdle tubes |
| 2 Clamp body (legs and base) | 4 Clamp mounting holes (quantity: 5) |



The upper girdle secures the flask within the clamp, and the bottom girdle keeps the flask from spinning.

4.9 Stacking Instructions

To stack two S41i incubator shakers, you must first have purchased the stacking kit. You will find the instructions contained in the kit.

4.10 Electrical Connections



CAUTION! Risk of electrical hazard

- ▶ Before making electrical connections, be sure to check the following list.

1. If you have not already done so, check that the voltage and frequency of your incubator shaker are compatible with your mains/electric supply.



NOTICE! Risk of material damage

- ▶ An earthed/grounded electrical outlet is necessary for the safe operation of this instrument.

2. Set the circuit breaker on the left side of the incubator shaker to the OFF position.

4.11 Setting Up

1. If necessary, level the incubator shaker by adjusting the feet, after removing the foot shields. Place a small level on the shelf of the incubator shaker. Adjust the leveling feet until the incubator shaker is level and stable. Lock the leveling feet in place by tightening the locking nuts on each foot. Reinstall the foot shields.
2. Fill each humidity tray halfway with water (approximately 250 mL) if you wish to use them for humidification.



Be sure to install the humidity trays one at a time, after wiping the bottom and edges dry. If you will not use them for humidification, install them anyway to catch spills.

3. Place the humidity trays one at a time onto the parallel support rods on either side of the bearing housing at the bottom of the incubator shaker. Sit them behind the stopper bends, making sure that the back edge of each tray fits under the end of the condensation/spill channel.

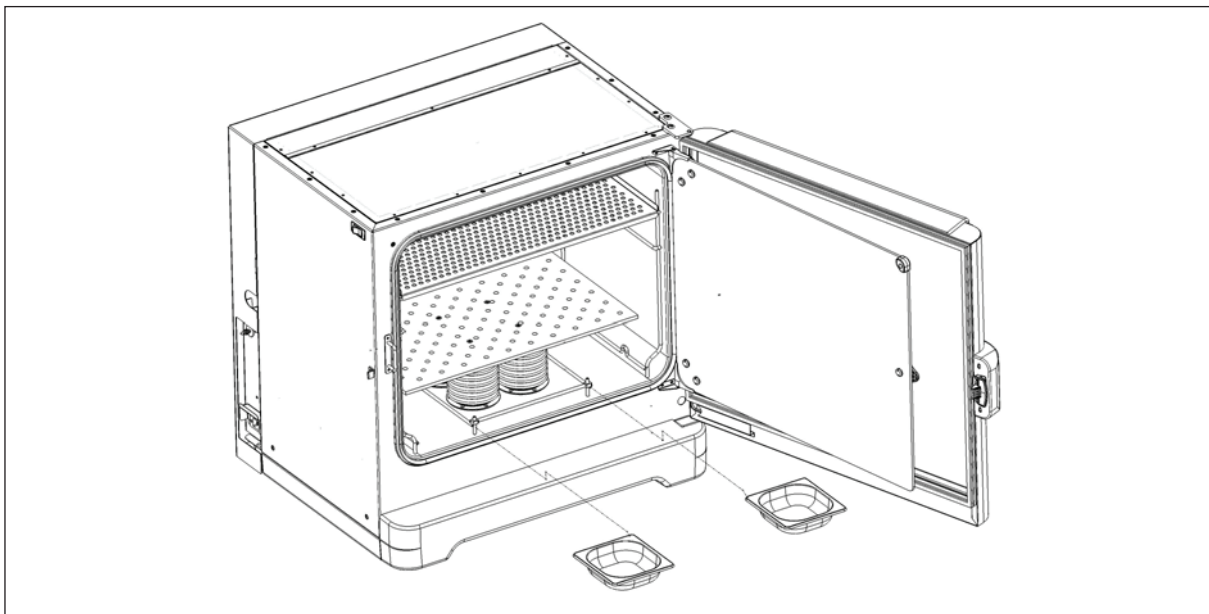

Fig. 4-9: Installing the humidity trays

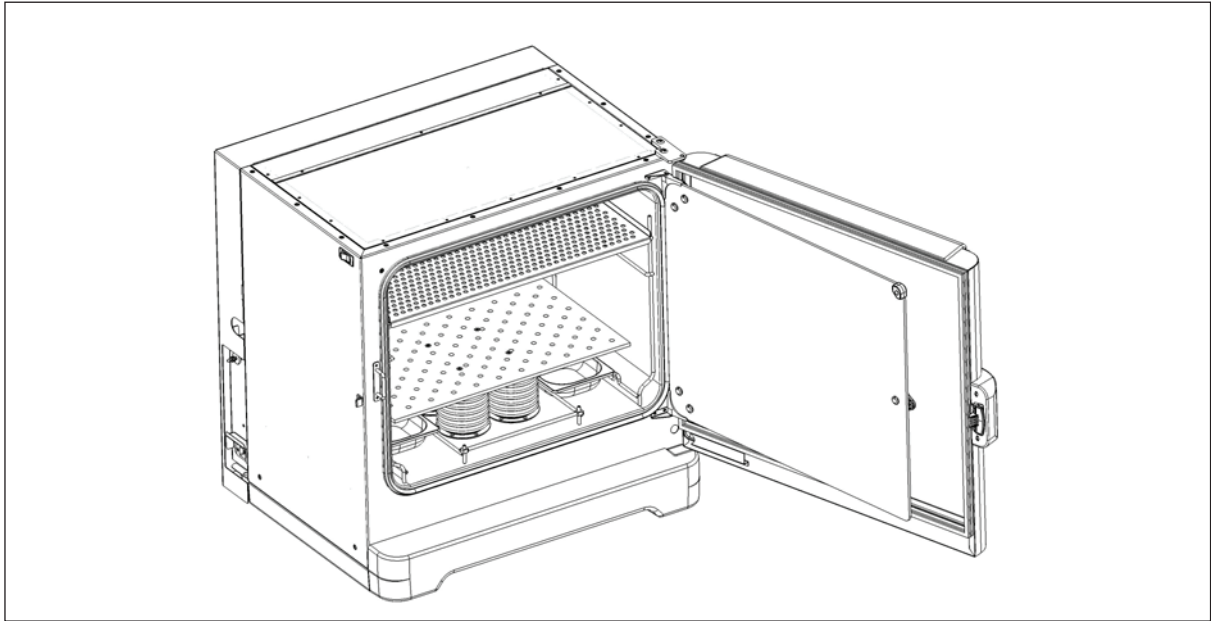

Fig. 4-10: Humidity trays, installed

4.12 Making Connections



WARNING! Risk of explosion

- ▶ Use gases in this equipment only within the range between their lower explosion limit (LEL) and their upper explosion limit (UEL).
- ▶ If your process requires or produces gases, be sure to verify their LEL and UEL concentration range (available online or ask your gas supplier).



In-line regulators are provided on the back of the incubator shaker. These are essential to proper operation.

1. Connect the incubator shaker to the CO₂ supply using the ~6 mm plastic tubing (with installed HEPA filter) by attaching the tubing from the supply to the top regulator inlet on the back of the incubator

shaker. The bottom regulator inlet is reserved for N₂ if your incubator shaker is equipped with the oxygen control option.

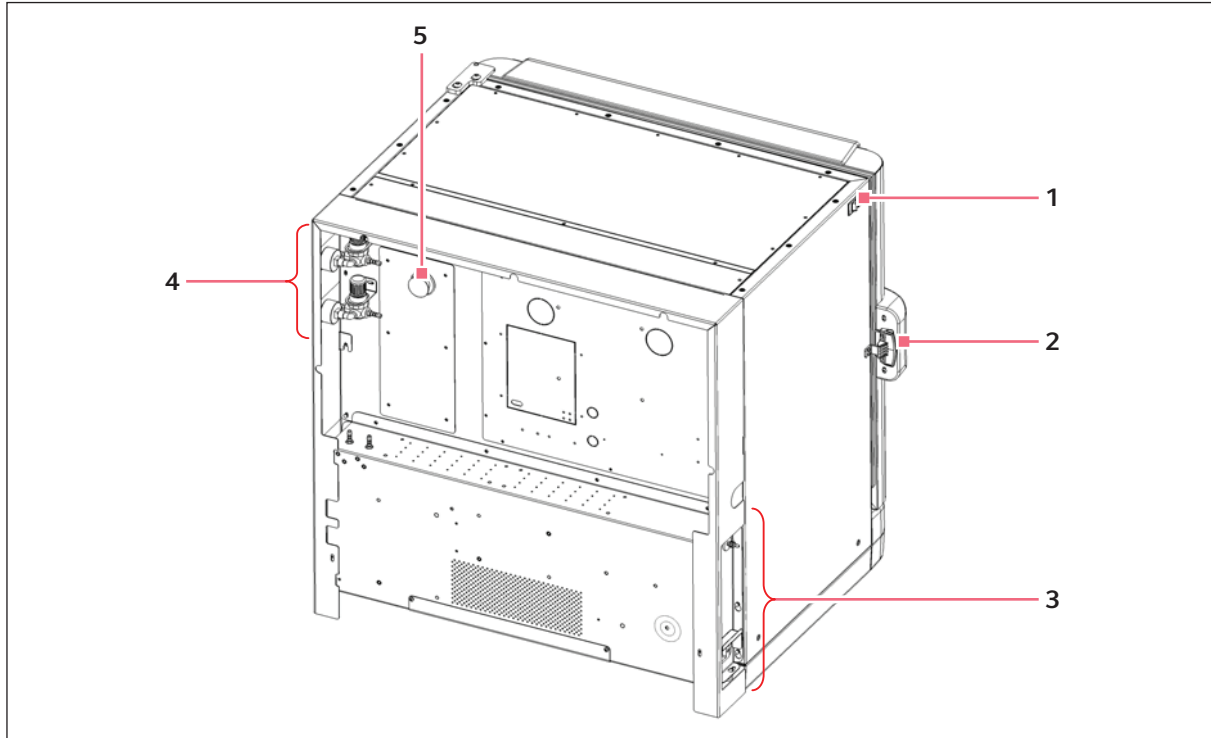

Fig. 4-11: Rear view (back panel removed)

- | | |
|---|--|
| 1 ON/OFF switch | 4 Inline gas regulators (access from the side) |
| 2 Door handle | 5 Access port |
| 3 See <i>Control box (right side)</i> figure for details. | |

2. Use the tubing clips provided to eliminate CO₂ leaks.



WARNING! Risk of electrical hazard

- ▶ Before making electrical connections, verify that your mains/power supply voltage matches the voltage of your incubator shaker and that the on/off switch is in the OFF position.

3. Plug the mains/power cord into its receptacle on the right side of the control box.
4. After verifying that your supply voltage matches the voltage specified for your incubator shaker and that the ON/OFF switch is OFF, plug the cord into your earthed/grounded mains/power supply outlet.
5. Press the Auto-Zero HEPA filter gently into the white plastic filter socket on the right side of the control box.

Installation

S41i CO₂ Incubator Shaker
English (EN)

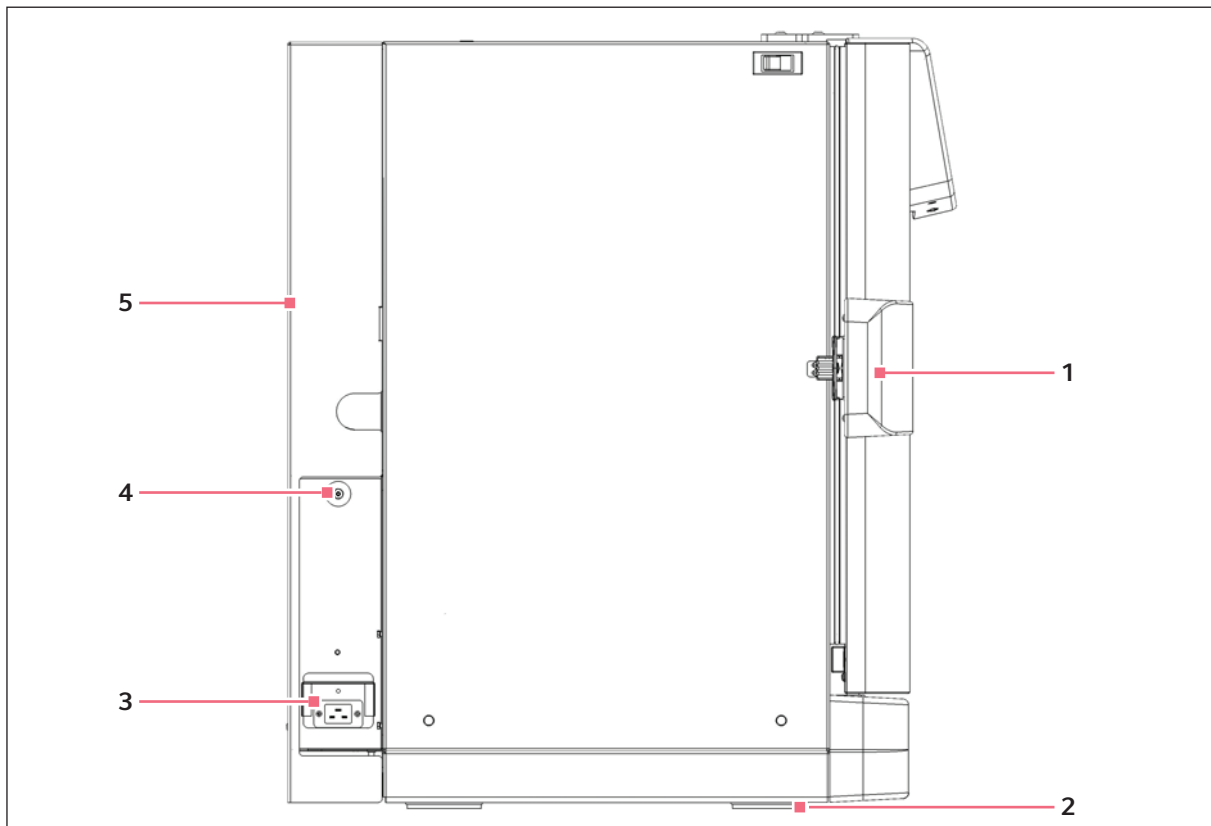

Fig. 4-12: Control box (right side)

- | | |
|--|---------------------------|
| 1 Door handle | 4 Auto-Zero filter socket |
| 2 Adjustable foot (shown with side shield) | 5 Back panel in place |
| 3 Mains/power receptacle | |

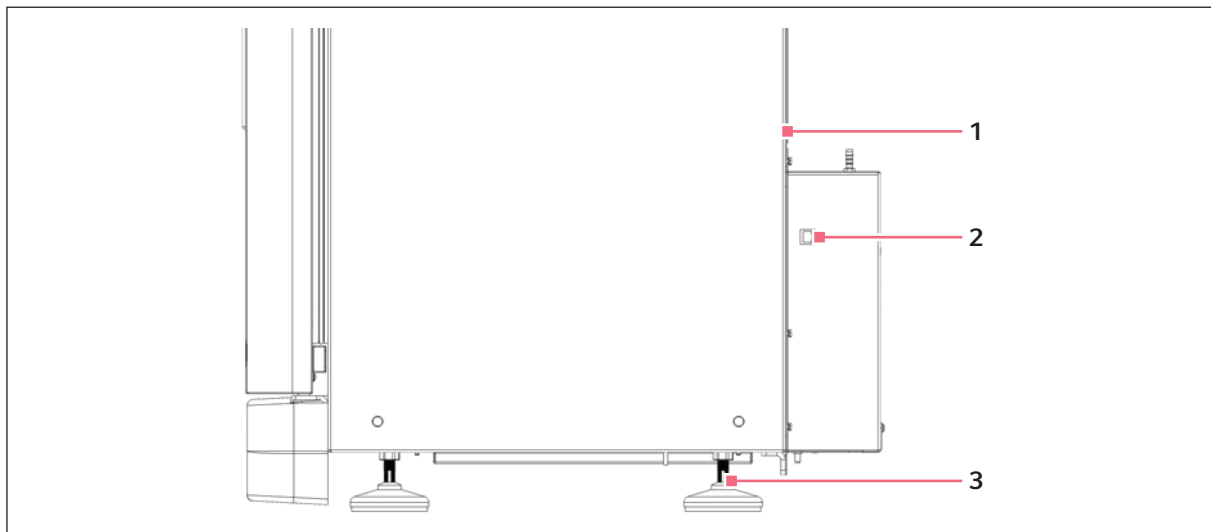

Fig. 4-13: Control box (left side)

1 (Shown with back panel removed)

3 Adjustable foot (shown without side shield)

2 Ethernet connection

4.13 Ethernet Connection

The ethernet connection is provided as a connection to a personal computer on which you can run *BioCommand® SFI* software to log data from its operation. Speak to your sales representative for information about this program.

4.14 BMS relay contact alarm

The BMS (Building Management System) Relay Contact Alarm allows a signal from a central alarm system to be switched ON or OFF to indicate an alarm condition at the incubator.

The following alarm conditions will activate the system: over-temperature, under-temperature, system failure, CO₂ high and CO₂ low.

As an integral option, the alarm can be programmed to indicate when the power fails (perhaps due to an electrical fault) or is switched off. If the power failure warning is active, the relay contacts will be reversed (pin 4, which is normally open, becomes normally closed and pin 6, which is normally closed, becomes normally open).

The system is connected at the rear of the incubator at the left side of the control box (close to the Ethernet connection) via a standard 6-pin DIN socket (see Fig. 4-13 on p. 29) for location. The matching plug is provided.

Installation

S41i CO₂ Incubator Shaker
English (EN)

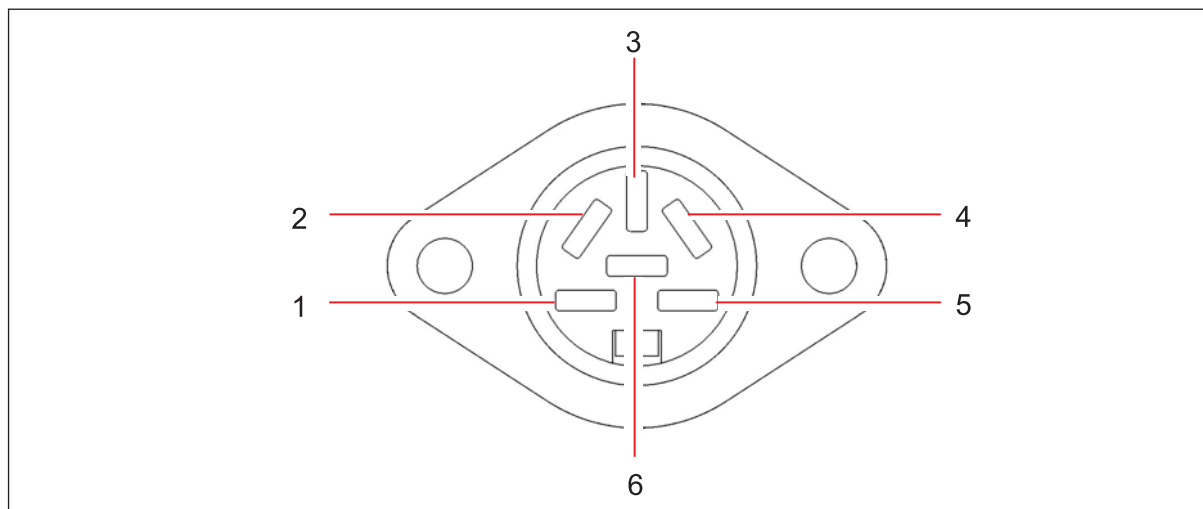

Fig. 4-14: BMS relay contact alarm socket

Pin		Designation
1 – 3	Not connected	
4	Normally closed	To access the relay contacts.
5	Common	Contact limits are 3 Amps @ 24 V DC and 3 Amps @ 34 V AC.*
6	Normally open	

*Cable length should not exceed 3 m (9.8 ft) to comply with EMC requirements.

The default setting for the alarm system is ON. To deactivate the relay using the incubator keypad:

1. Press USER.
2. Select BMS ALARM RELAY.
3. Select MAKE ALARM RELAY ACTIVE YES/NO.
4. Toggle to NO and then press ENTER.

The default setting for the power failure warning is ON. To make the alarm system ignore any power outage:

1. Press USER.
2. Select BMS ALARM RELAY.
3. Select MAKE ALARM RELAY ACTIVE AT POWER SWITCH OFF/FAILURE YES/NO.
4. Toggle to NO and then press ENTER.

5 Operation

5.1 Preparing for Operation

1. Remove the black protective cover from the CO₂ sensor, and store it in a safe place. The sensor cap should be placed back on the sensor when the incubator shaker is to be cleaned.
2. Ensure that the white porous sensor cover remains in place.
3. Using the mains/power cord provided, connect the incubator shaker to a earthed/grounded mains/power supply.
4. Switch the incubator shaker ON using the on/off switch at the top left side of the incubator shaker. The display will illuminate immediately.
5. Turn on the CO₂ gas supply with the pressure regulator set to 7 PSI (0.5 bar).
6. The chamber setpoints are pre-programmed at 37.0 °C and 5 % CO₂. Leave the incubator shaker on until the programmed chamber temperature and CO₂ concentration have been reached.



- The incubator shaker's CO₂ valve is disabled until the incubator shaker reaches the temperature setpoint. After the temperature setpoint is reached, the CO₂ valve is activated, allowing the incubator shaker to reach the CO₂ setpoint.
 - If mains/power is interrupted to the incubator shaker long enough for the temperature to drop below setpoint, the CO₂ valve will be deactivated until temperature setpoint is again achieved. (This serves to avoid spurious CO₂ readings while the incubator shaker is below its temperature setpoint)
7. Leave the incubator shaker running overnight to allow conditions to stabilize.

5.2 Using the Humidity Trays

If humidification is required, each of the two humidity trays should be filled with approximately 250 mL of warm (~ 37.0 °C) distilled water at this time.



NOTICE! Risk of material damage

- ▶ To avoid possible damage to the CO₂ sensor, never leave water in the humidity trays while the incubator shaker is switched off, or when a high temperature disinfection cycle is initiated.
 - ▶ Allow a clearance of 50 mm (2 in) to allow access for oxygen sensor removal (optional feature).
-

The humidity level within the chamber is not adjustable. The internal chamber will reach between 85 and 95 % relative humidity at 37 °C (depending on ambient humidity) using the humidity trays.

OperationS41i CO₂ Incubator Shaker

English (EN)

5.3 Starting the Incubator Shaker



The incubator shaker will not operate if the door is open.

To initially start the incubator shaker, close the door, make sure the incubator shaker's mains/power cord is securely plugged in, and turn the mains/power switch (located on the top left side of the instrument) to the **ON (I)** position.

The initial display will come on for a few moments, then you will see the **STATUS** screen (see *Preparing for Operation* on p. 31).

In the unlikely event that the audible alarm sounds upon start-up, a yellow **ALARM** screen will appear, prompting you to mute and to acknowledge the alarm:

1. Press the **Mute** button in the screen to silence the audible alarm.
2. If you have Administrator status (see *USER ACCESS* screen on p. 54), follow the instructions to acknowledge the alarm; if you have User status, get an Administrator to acknowledge the alarm.
3. Use the **LEFT** and **RIGHT** arrow buttons to see if there are any other alarms to acknowledge.
4. If any alarms continue to be unacknowledged, there will be a yellow star behind the **ALARM** icon in the **STATUS** and **SUMMARY** screen until the alarm is acknowledged.
5. After acknowledgement, the reason for any alarm should be tended to and rectified. For details on using alarms (see *ALARM SETTINGS* screen on p. 39).

5.4 Using the Touchscreen

5.4.1 Initial display and STATUS screen

This is the first screen you will see when you turn the incubator shaker ON:



This is a sample screen, the version number shown will vary.

1

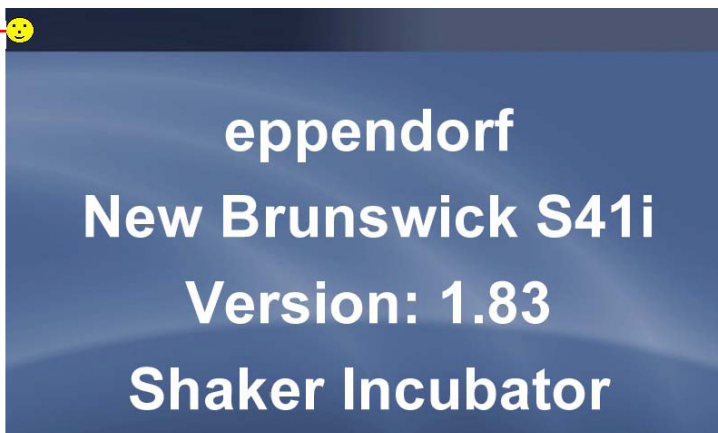

- 1 The yellow smiling icon in the upper lefthand corner of each screen indicates that the software is working. If at any time you see a red frowning icon, the software is not working and will require troubleshooting.

The initial screen will remain displayed for a few moments, then change to the **STATUS** screen:



-  If the display showed the **SUMMARY** screen when it was powered off, when you restart, the **SUMMARY** screen (see *SUMMARY screen on p. 41*) will appear instead of the **STATUS** screen. You may need to calibrate the touchscreen to your touch (see *SET CALIBRATION screen on p. 46*).



If the **ALARM** icon appears, an alarm condition exists. This needs to be acknowledged and rectified. Go to the **ALARMS** screen (see *ALARM SETTINGS screen on p. 39*).

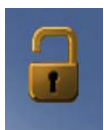

The presence of the open **LOCK** icon indicates that the user screens are unlocked for access to make changes. When the padlock is closed, the screens are locked against changes; Admin level security is required to make edits.

5.4.2 Starting the platform

The **STATUS** or **SUMMARY** screen will display a **START** button to launch operation of the incubator shaker platform. The **START** button changes to a **STOP** button when pressed.

1. Press **START** from **STATUS** or **SUMMARY** screen.
The confirmation screen appears.

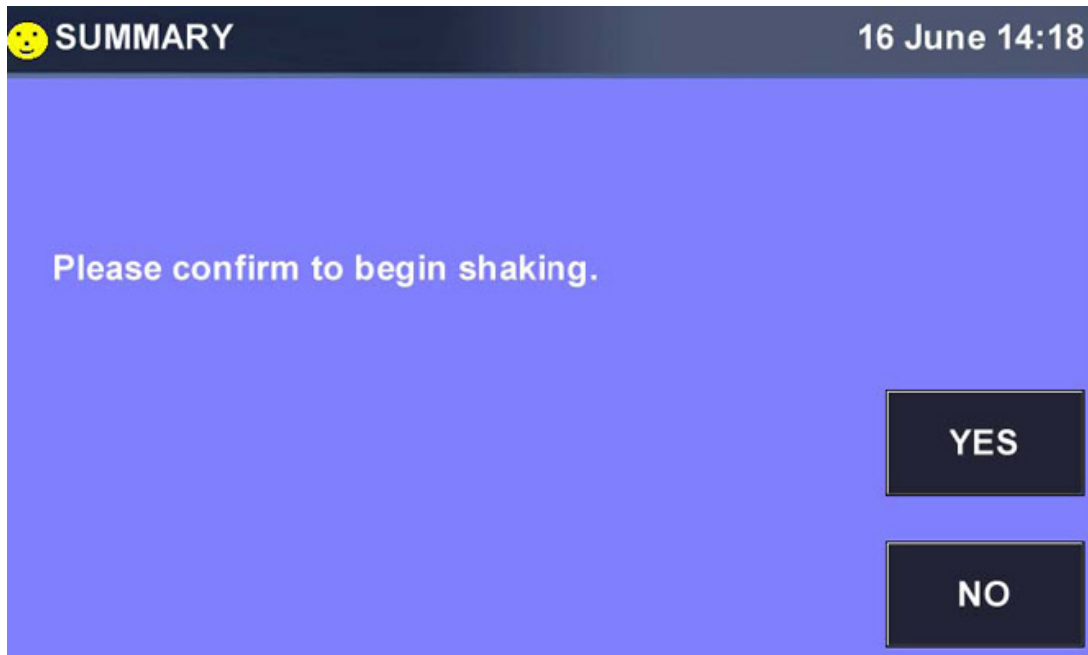

2. Press *YES* to start the incubator shaker platform.

The **STATUS** or **SUMMARY** screen displays the *STOP* button.

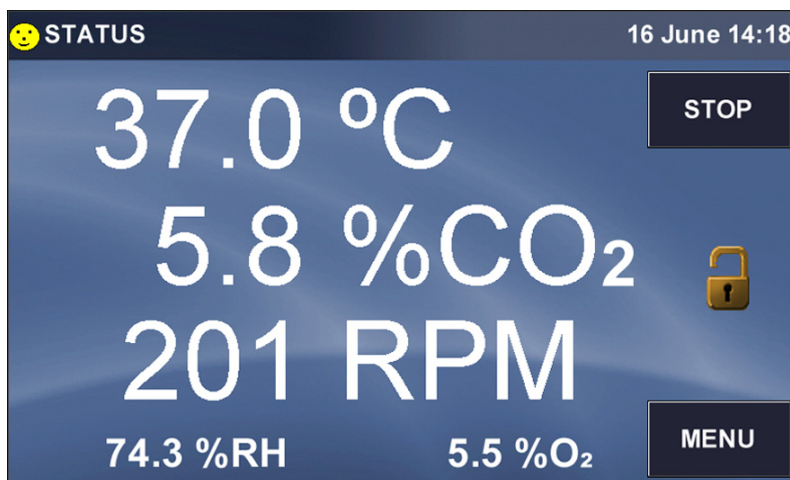

5.4.3 Stopping the platform

The **STATUS** or **SUMMARY** screen will display a *STOP* button to stop operation of the incubator shaker platform. The *STOP* button changes to a *START* button when pressed.

1. Press *STOP* from **STATUS** or **SUMMARY** screen. The confirmation screen appears.

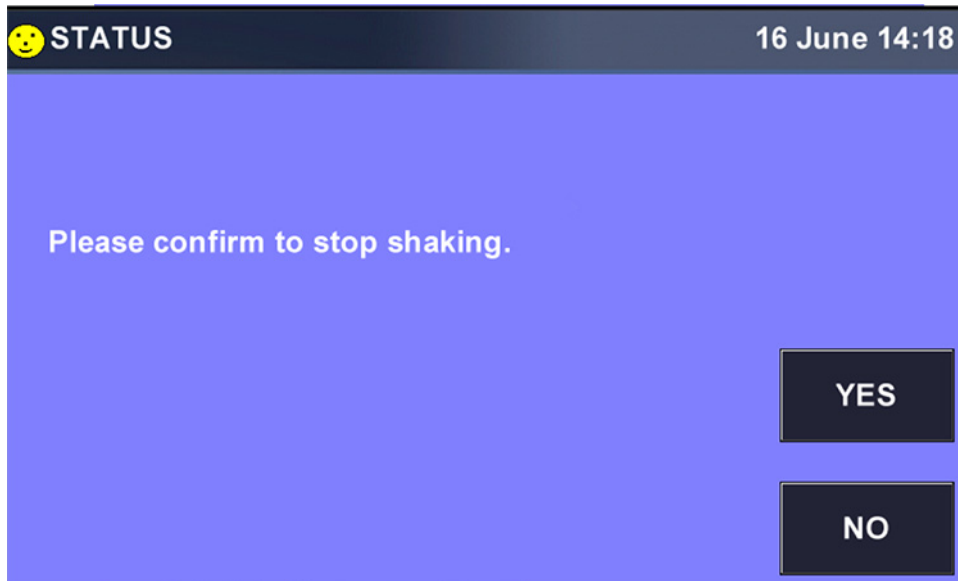

2. Press *YES* to stop the incubator shaker platform. The **STATUS** or **SUMMARY** screen displays the *START* button

5.4.4 Setting the temperature

At any time you can press the °C line in the **STATUS** screen to open the Temperature Range screen, which allows you to set temperature parameters:

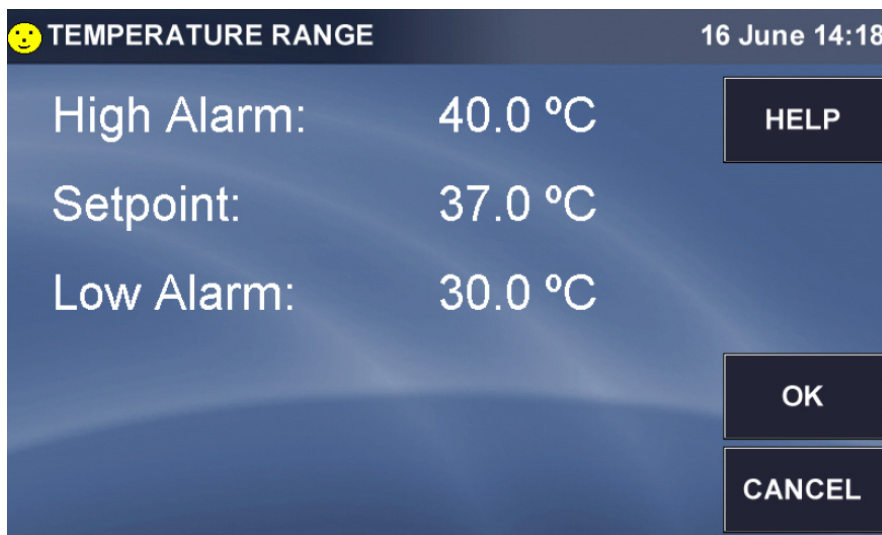

- ▶ Press the High Alarm line and use the popup keypad to set the temperature at which an alarm will alert you to the temperature rising too high.
- ▶ Press the Low Alarm line and use the popup keypad to set the temperature at which an alarm will alert you to the temperature falling too low.

OperationS41i CO₂ Incubator Shaker

English (EN)

- ▶ Press the Setpoint line and use the popup keypad to set the desired working temperature.

5.4.5 Setting the CO₂ level

At any time you can press the CO₂ line in the **STATUS** screen to open the CO₂ Range screen, which allows you to set parameters for carbon dioxide in the chamber:



- ▶ Press the High Alarm line and use the popup keypad to set the percentage at which an alarm will alert you to the CO₂ level rising too high.
- ▶ Press the Low Alarm line and use the popup keypad to set the temperature at which an alarm will alert you to the CO₂ level falling too low.
- ▶ Press the Setpoint line and use the popup keypad to set the desired percentage of CO₂ in the chamber.

5.4.6 Setting the shaking speed

At any time you can press the **RPM** line in the **STATUS** screen to open the Speed Range screen, which allows you to set parameters for the shaking speed and run time:

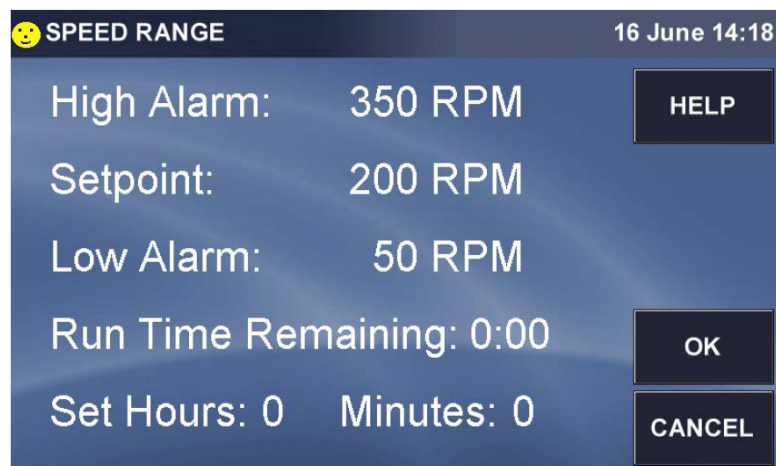

- ▶ Press the High Alarm line and use the popup keypad to set the speed at which an alarm will alert you to the rpm rising too high.
- ▶ Press the Low Alarm line and use the popup keypad to set the speed at which an alarm will alert you to the rpm level falling too low.
- ▶ Press the Setpoint line and use the popup keypad to set the desired shaking speed.
- ▶ Press the Set Hours line to set the number of hours of shaking you wish to program, using the popup keypad.
- ▶ Do the same to Set Minutes.
- ▶ After you program the Hours and Minutes of the run time and then press *OK* the button to return to the **STATUS** screen.
- ▶ Now there will be a *STOPWATCH* icon next to **RPM**, to indicate that the countdown of Run Time has been enabled:

5.5 MENU 1 Screen

- ▶ Press *MENU* button to open the first of two **MENU** screens:



- ▶ Press the *Status View* button or *DONE* button at any time to return to the main **STATUS** View screen.
- i** When you press the *DONE* button in the **MENU** screen's , if you had previously been viewing the **SUMMARY** screen, the system will return you to the **SUMMARY** screen.

5.5.1 HELP function

- ▶ Whenever there is a *HELP* button in a screen, you can press it at any time to find additional information regarding the screen you are viewing.

5.5.2 EVENT LOG

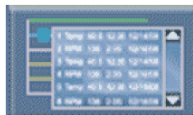
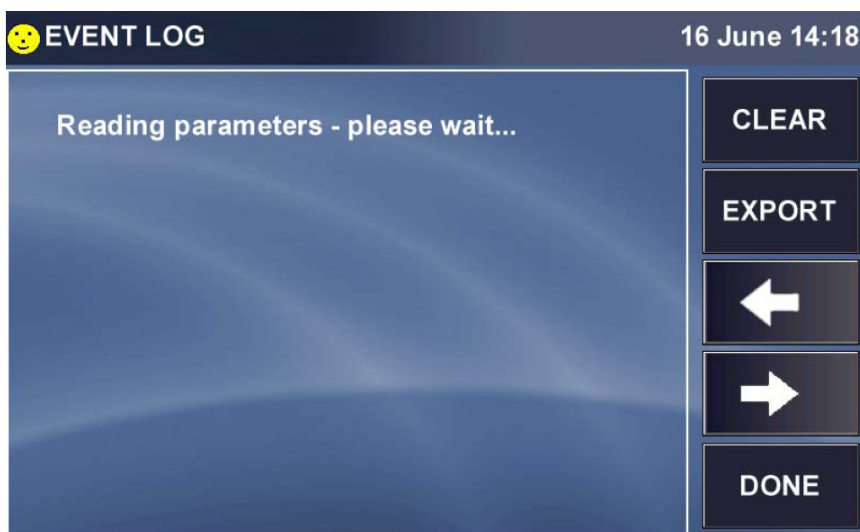
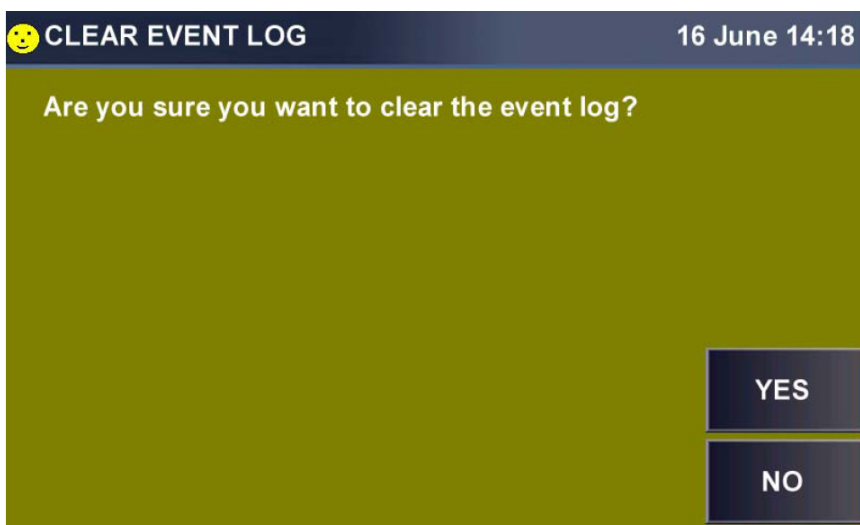

Fig. 5-1: Event log button

- ▶ In the first **MENU** screen, press the *Event Log* button to open the **EVENT LOG**:



- ▶ Press any of the events listed in this screen to open an **EVENT DETAIL SCREEN**, then press the *DONE* button to return to the **EVENT LOG** screen.
- ▶ To clear the **EVENT LOG** screen, press the *CLEAR* button; you will be prompted to confirm your choice with this screen:



- ▶ Press the *YES* button to clear the log; press the *NO* button to return to the **EVENT LOG** screen without making changes.

- ▶ Press the *EXPORT* button to save event log data to a USB memory stick/flash drive. You will be prompted with the following screen:

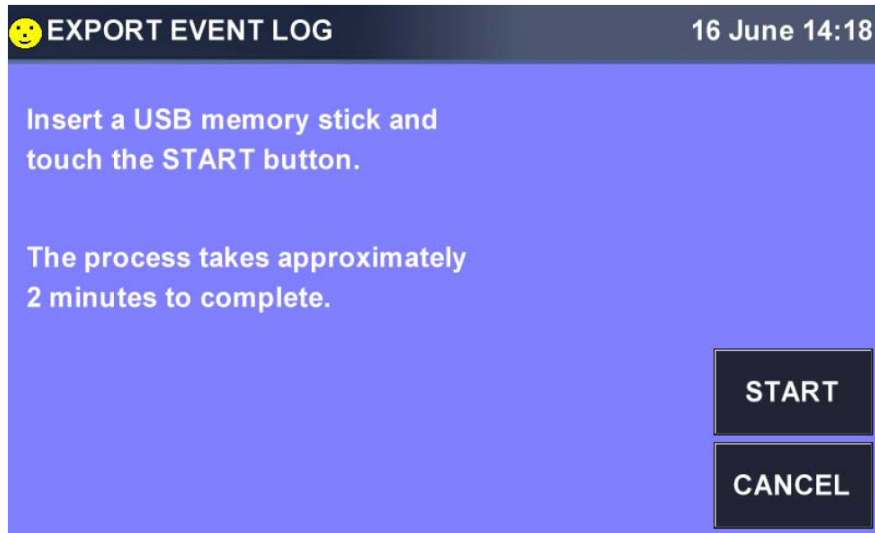

- ▶ Insert the memory stick/flash drive in the USB port located under the touchscreen, then press the *START* button.
- ▶ In the **EVENT LOG** screen you can also press the *LEFT* or *RIGHT* button to view previous or additional **EVENT** data screens.
- ▶ Press the *DONE* button to return to **MENU**.

5.5.3 ALARM SETTINGS screen

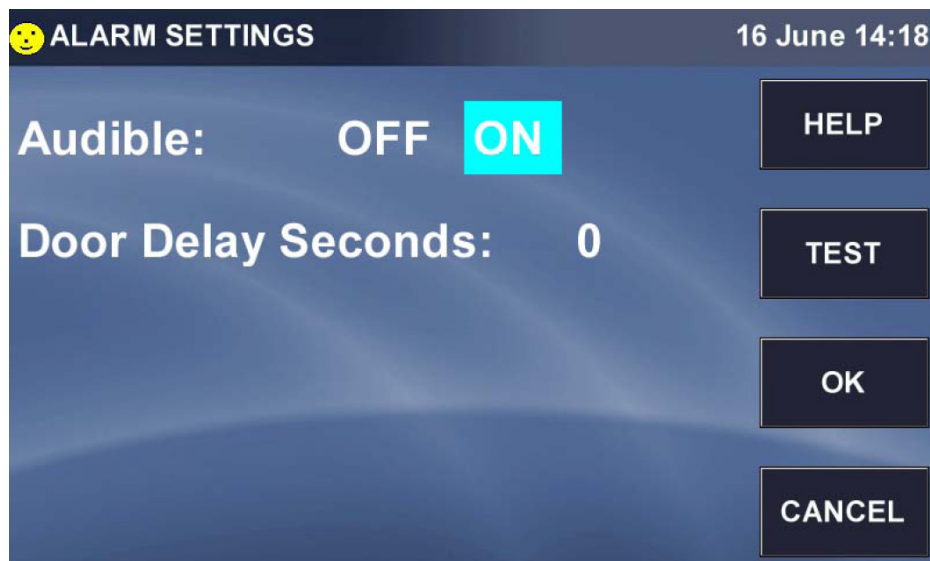

Fig. 5-2: Alarms button

Operation

S41i CO₂ Incubator Shaker
English (EN)

- ▶ Press the *ALARMS* button in the **MENU 1** screen to open the **ALARM SETTINGS** screen:



The Audible alarm is either ON or OFF, whichever is highlighted in your screen (it is ON in the sample screen above). To change its status, press anywhere in this line except where it is already highlighted, and it will automatically change.

If an audible alarm is triggered:

- ▶ Mute and acknowledge alarm (see *Starting the Incubator Shaker on p. 32*), and rectify the condition that triggered the alarm.

When the door is opened, an alarm is displayed and logged. To delay the triggering of the open door alarm:

- ▶ Press anywhere in the **Door Delay Seconds** line.
- ▶ In the **SET DOOR DELAY SECONDS** keypad that opens:

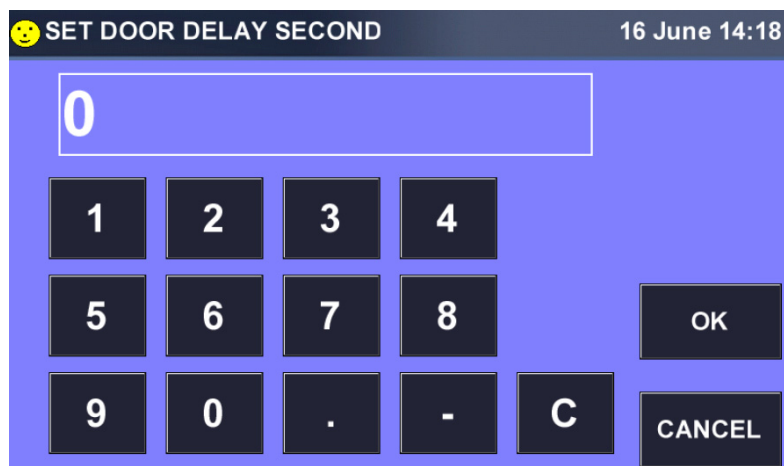

- ▶ Use the keys to enter the desired delay in seconds, then press the *OK* button to save the value. You will return to the **ALARM SETTINGS** screen and your value will be displayed.

If you wish to test the alarms:

- ▶ press the *TEST* button to open the **ALARM TEST** screen:

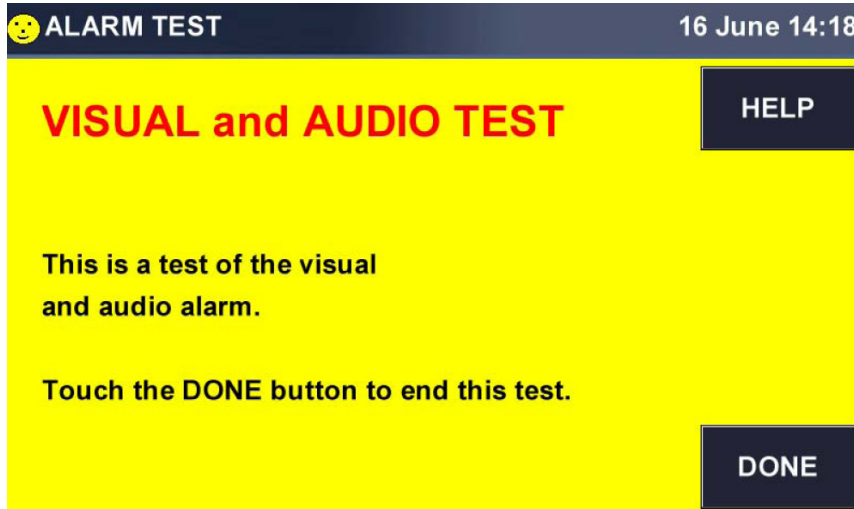

The test will begin automatically with the opening of this screen. You should see a yellowcolored screen with red lettering at the top, symbolizing a visual alarm, and you should hear an audio alarm.

- ▶ Press *DONE* button to acknowledge the test and to stop the audio alarm.
- ▶ Press the *OK* button in the **ALARM SETTINGS** screen at any time to return to the **MENU** screen.

5.5.4 SUMMARY screen

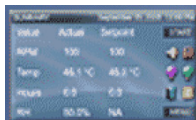
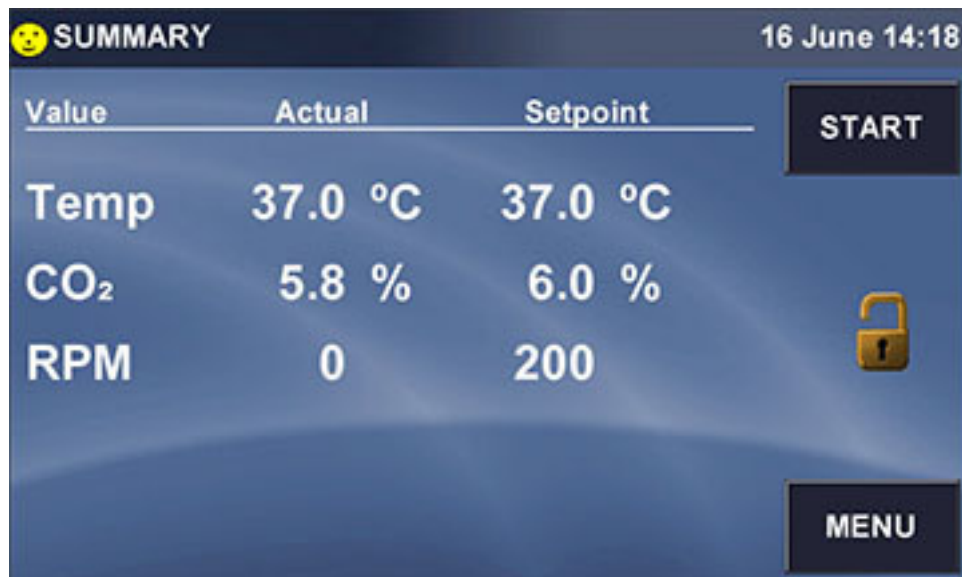

Fig. 5-3: Summary view button

- ▶ Press the *Summary View* button to open the **SUMMARY** screen.



Like the **STATUS** screen, the **SUMMARY** screen has a *START* button which, once it has been pressed to launch operation, becomes a *STOP* button to allow you to stop operation.

If the icon appears, an alarm condition exists. This needs to be acknowledged and rectified. Go to the **ALARMS** screen (see *ALARM SETTINGS screen on p. 39*).

The presence of the open *LOCK* icon indicates that the user screens are unlocked for access to make changes. When the padlock is closed, the screens are locked against changes; Admin level security is required to make edits.

The following table identifies the five values (parameters) that may appear in abbreviated form in the lefthand column of the **SUMMARY** screen:

Abbreviation	Value
Temp	Temperature (°C)
CO ₂	Carbon Dioxide (%)
RPM	Shaking speed (rpm)

As with the **STATUS** screen, press any Setpoint to open that parameter's screen to set or reset the Setpoint.

When you set a Run Time, the *STOPWATCH* icon appears next to RPM in the **SUMMARY** screen, too:

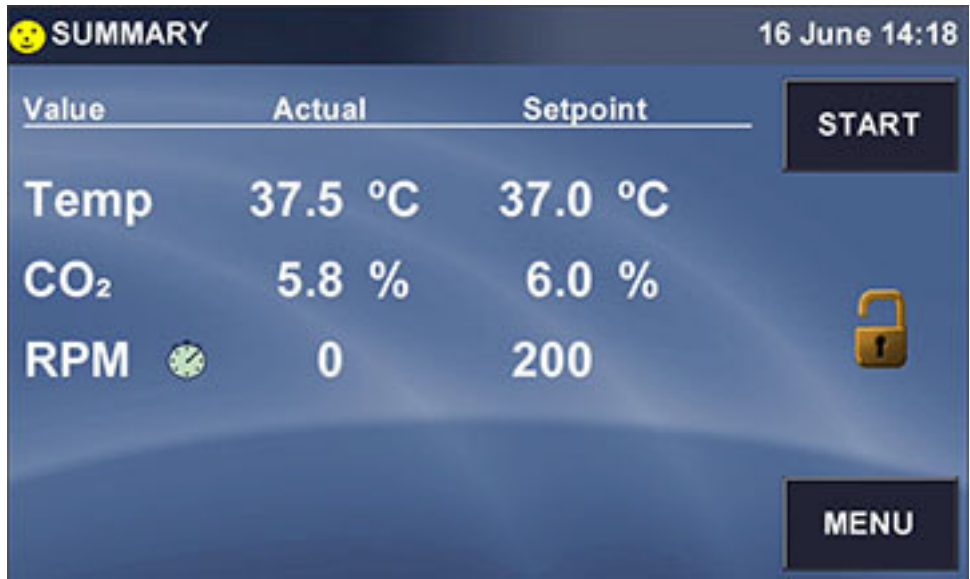

5.5.5 EVENT GRAPH screen

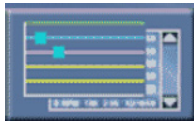
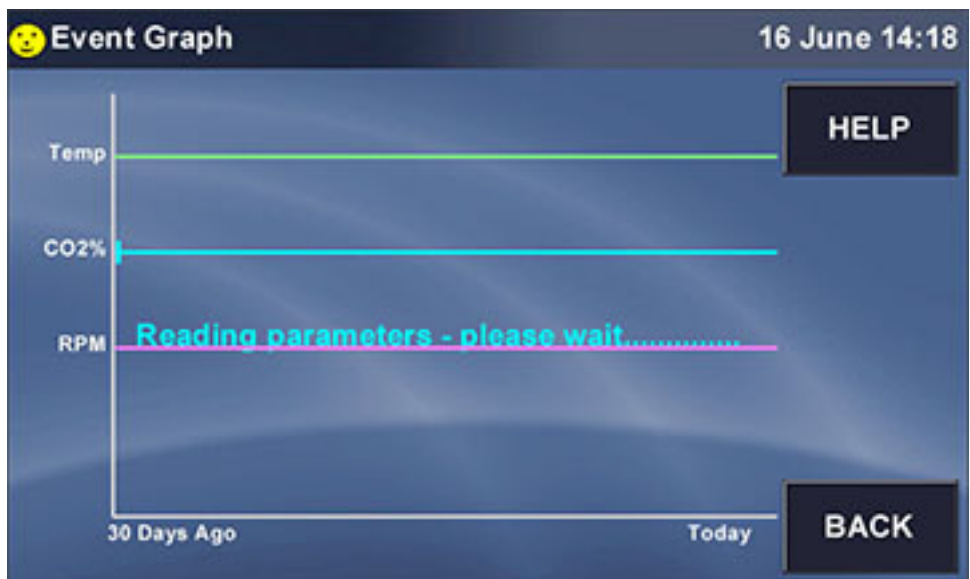
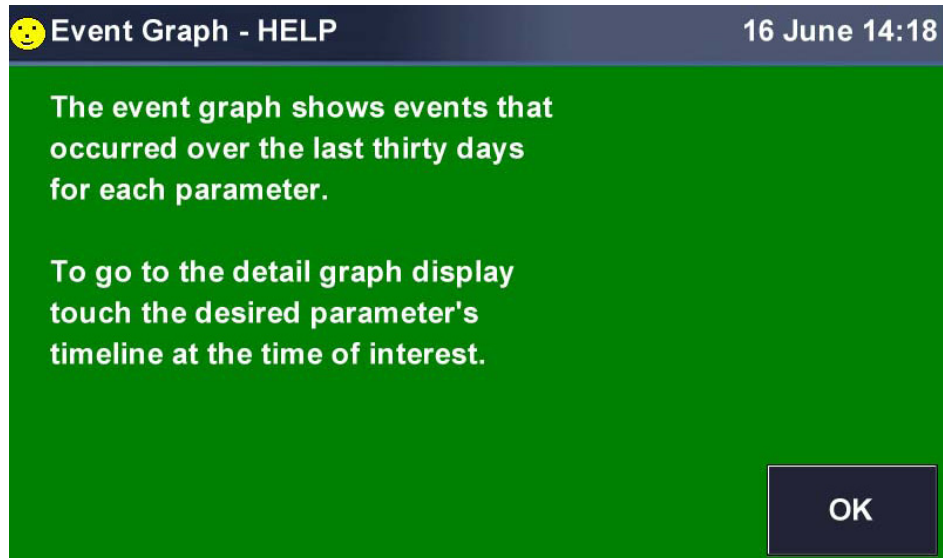

Fig. 5-4: Event graph button

- ▶ Press the *Event Graph* button to open the **EVENT GRAPH** screen:



If you press the *HELP* button, the following screen will appear:



The *BACK* button returns you to the **MENU** screen.

- ▶ Press any parameter's graph line to open that particular graph.

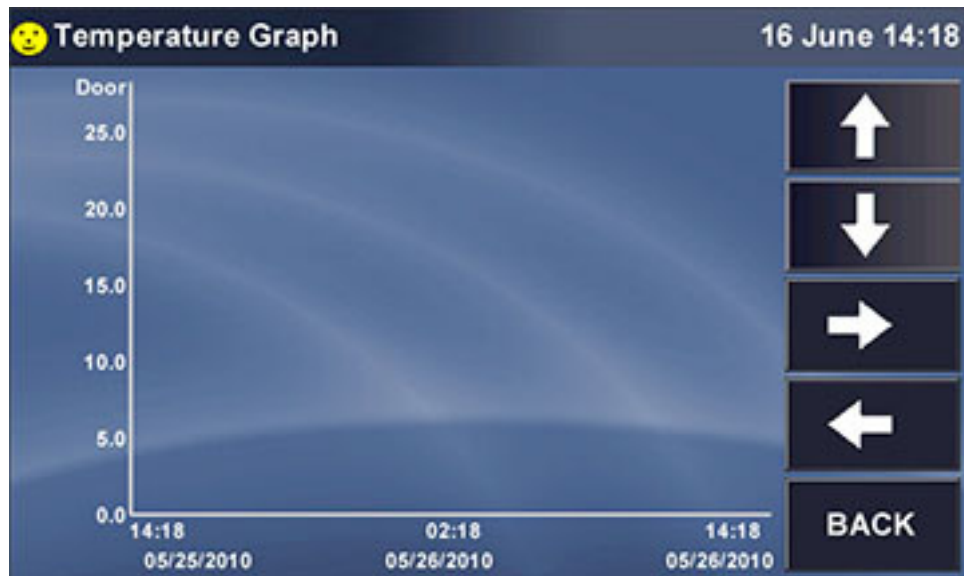

- ▶ Click anywhere along the Y (vertical) axis to open a Span popup screen that allows you to change the scale of this axis:

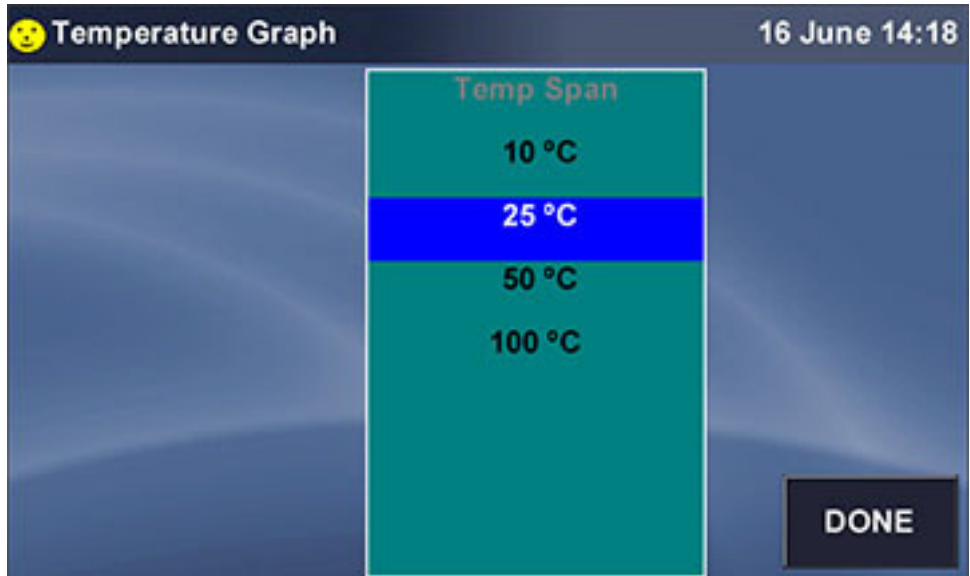

The current view shows from 0.0 °C to 25.0 °C. If you press, for example, 10 °C then press the *DONE* button, the X axis will change to display a scale from 0.0 °C to 10.0 C.

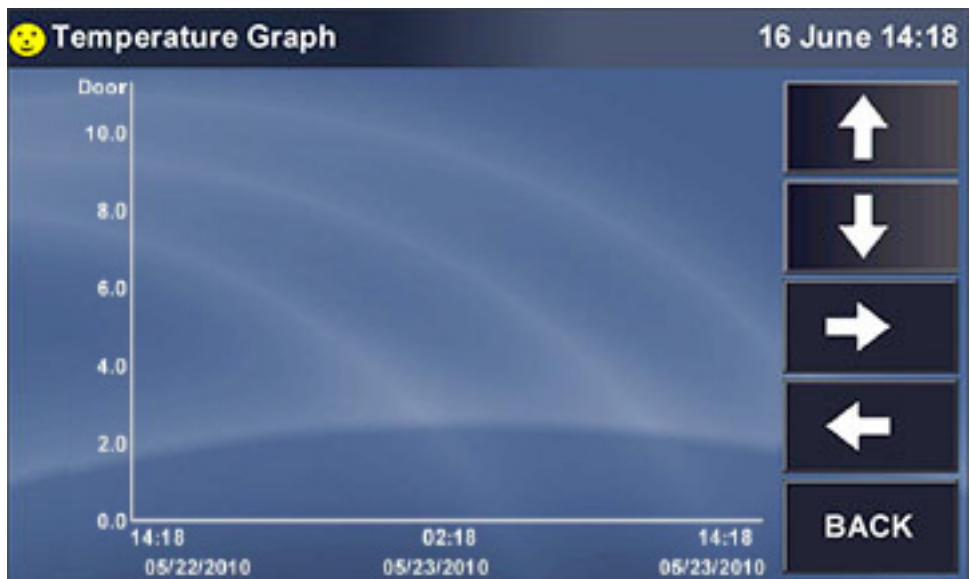

- ▶ Press anywhere along the X axis to open a Time Span popup screen:



- ▶ Press any selection, "3 Days" for example, then press the *DONE* button. The X-axis will now show a time span of 3 days onscreen, between the 1st marker on the left and the 3rd on the right.
- ▶ At any time, you can use the *UP* and *DOWN* arrow buttons to scroll through values, and use the *LEFT* and *RIGHT* arrow buttons to scroll through Time.

5.5.6 SET CALIBRATION screen

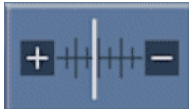
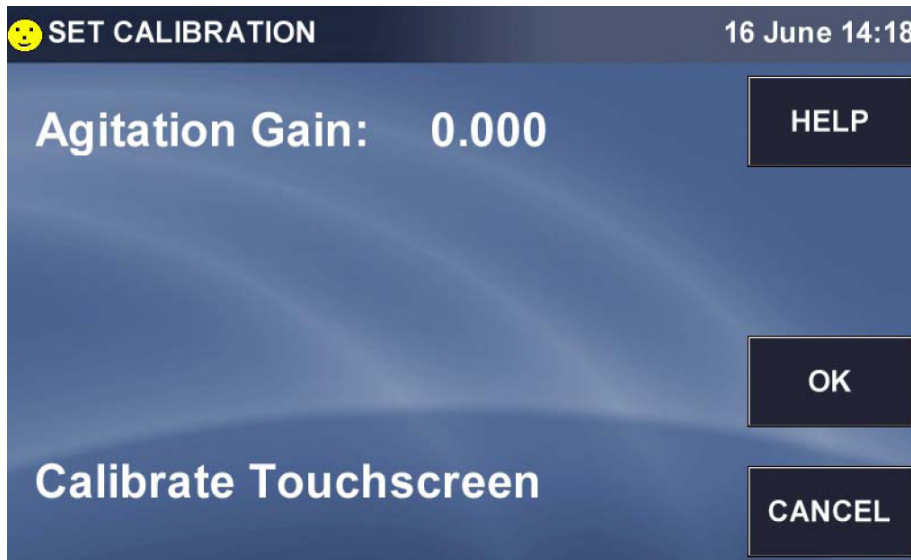

Fig. 5-5: Calibrate button

► Press *Calibrate* button to open the **SET CALIBRATION** screen:



The following sections explain the options offered in this screen.

5.5.6.1 Agitation gain

If you measure the shaking speed (“Actual Speed”) with a tachometer and find that it does not match the speed displayed in the **STATUS** and **SUMMARY** screens (“Indicated Speed”), proceed as follows:

1. Let the unit arrive at the desired shaking speed, then record the Indicated Speed from the display.
2. Use a tachometer to measure the speed and record the Actual Speed.
3. Calculate the Speed correction value using this formula:
Actual Speed – Indicated Speed = Agitation Gain Value.
4. In the **SET CALIBRATION** screen, press anywhere in the Agitation Gain line. This screen will open:

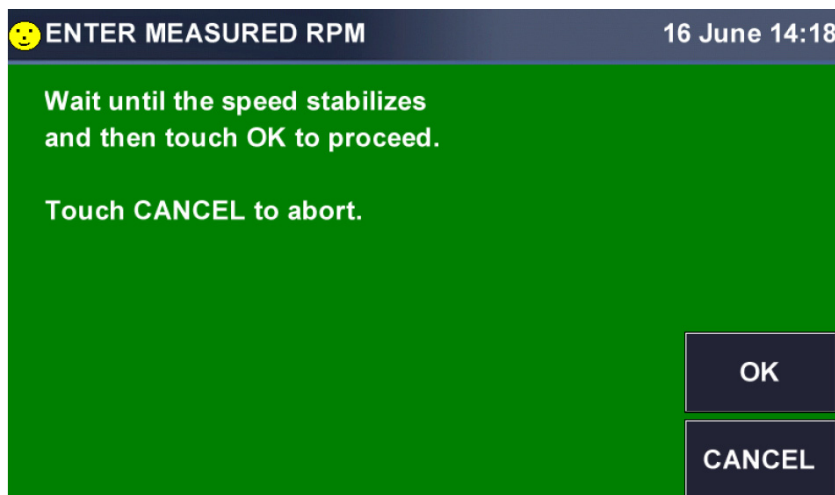

5. When the speed stabilizes, press the *OK* button. This screen will open:

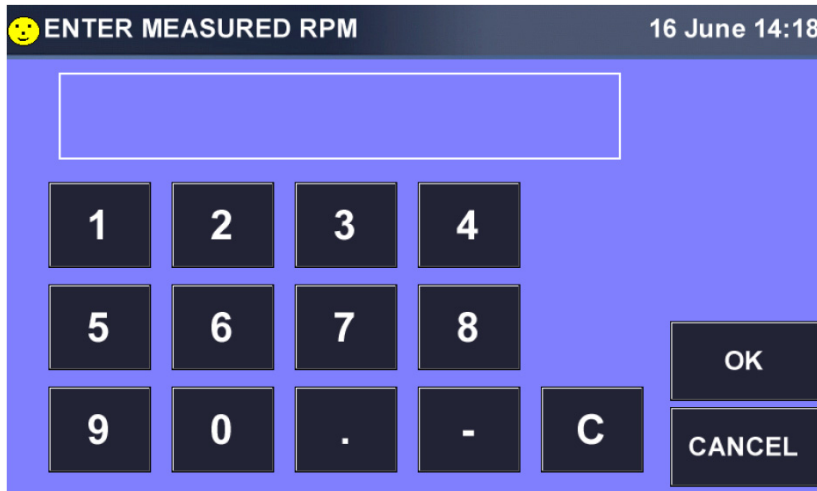

i No setpoint or agitation gain below 100 rpm or above 400 rpm can be entered.

6. Use the keypad to enter the RPM as you measured it, then press the *OK* button to save the value.

This allows the system to recalibrate agitation speed.

5.5.6.2 Calibrate touchscreen

- ▶ To calibrate the touchscreen, press *Calibrate Touchscreen* and follow the instructions in the screen that opens. You will be prompted to touch the screen at several locations. When the calibration has been completed, the system will return to the **SET CALIBRATION** screen.
- ▶ Press the *OK* button to return to the **MENU**.

5.5.7 GENERAL SETTINGS screen



Fig. 5-6: General settings button

- ▶ Press the *General Settings* button to open the **GENERAL SETTINGS** screen:

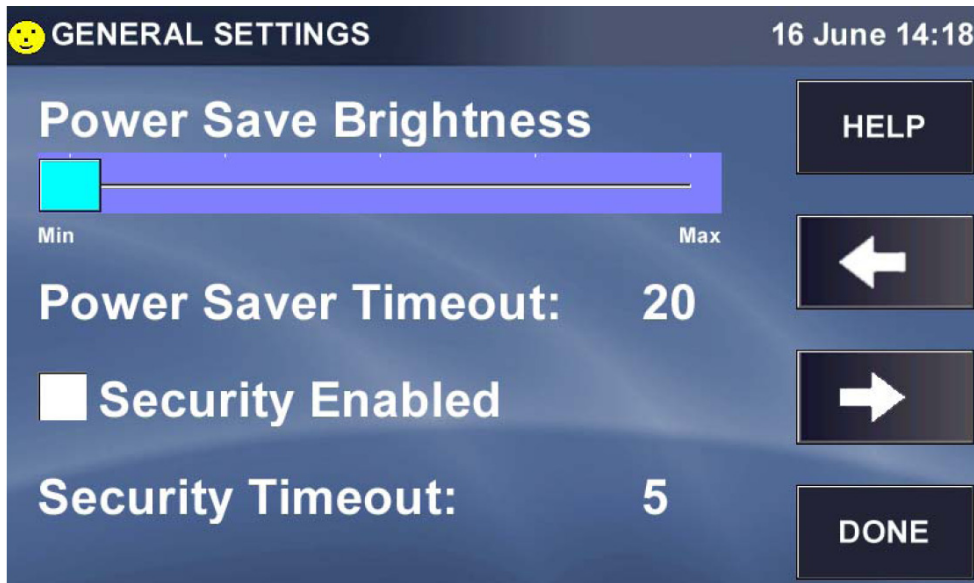

The **Power Save Brightness** setting governs the degree of brightness or dimness that you see onscreen when the screen enters Power Save mode.

- ▶ Click inside the **Power Save Brightness** bar to move the light blue marker to any of 5 choices ranging between **Min** and **Max**.

This sample screen shows the marker moved from **Min**, where it was previously, to midrange:

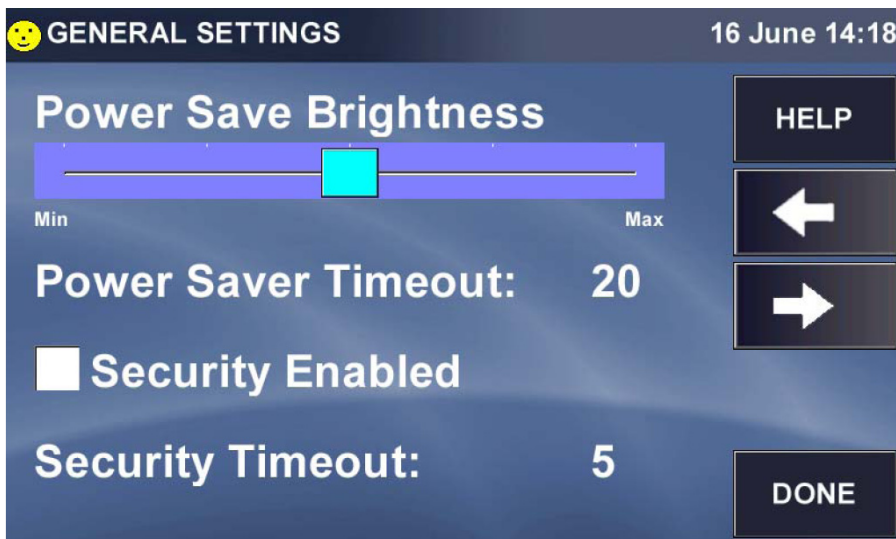

The **Power Saver Timeout** is the time after which, if the display remains untouched, the screen will dim.

Operation

S41i CO₂ Incubator Shaker
English (EN)

- ▶ Press *Power Saver Timeout* to set or reset the timeout duration. In the **SET POWER SAVE MINUTES** keypad screen that opens:

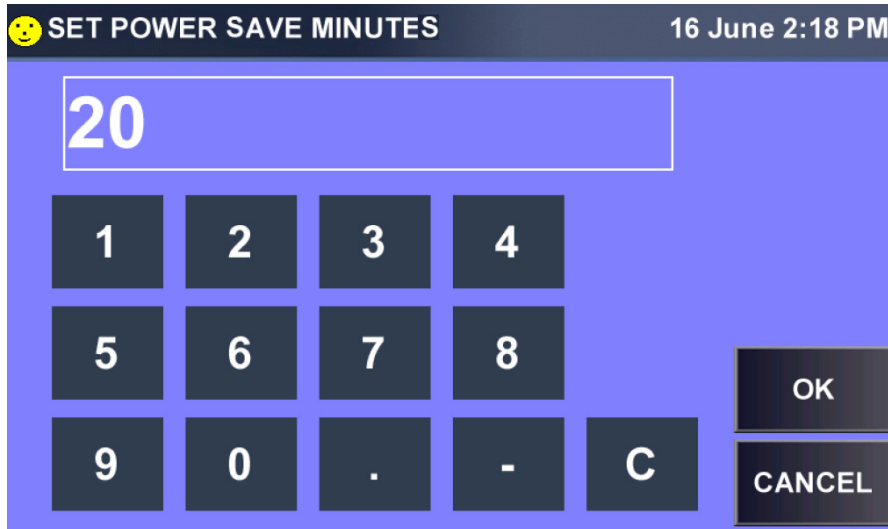

- ▶ Input the desired number of minutes, then press *OK*.
- ▶ If **Security** is not enabled (the check box is empty, as shown in sample **GENERAL SETTINGS** screen), press **Security** or press inside the checkbox to enable it:

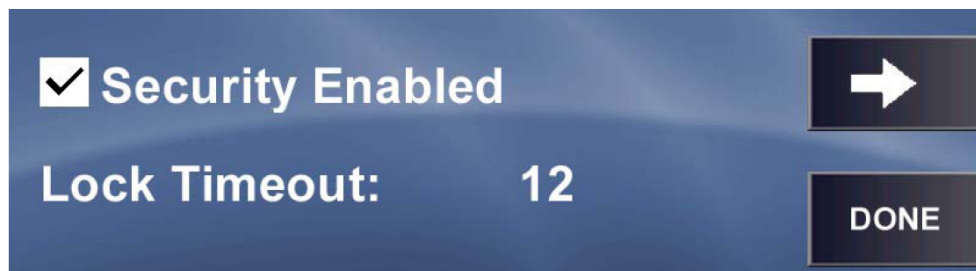

If you do not have Administrative authority, you will see this screen:

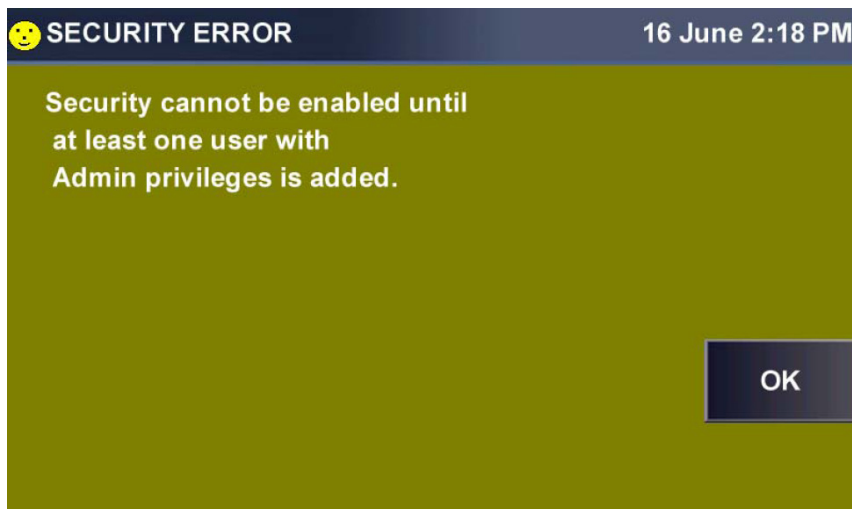

- ▶ Press the *OK* button to acknowledge this message to return to the **GENERAL SETTINGS** screen.

i When Security is enabled, the padlock icon on the SUMMARY and STATUS screens will be closed, and users will have access to only the SUMMARY and STATUS screens. In fact, the MENU button in the SUMMARY screen will have changed to a VIEW button.

The Lock Timeout is the time of screen idling after which, when Security is enabled, the system will lock itself. The padlock will change from unlocked to locked and a user with Administrative privileges (see *USER ACCESS screen on p. 54*) must log on to unlock the system.

- ▶ Press Lock Timeout to set or change the duration.
- ▶ In the **SET LOCK TIME MINUTES** keypad that opens, press the keys to input the desired time, then press the *OK* button:

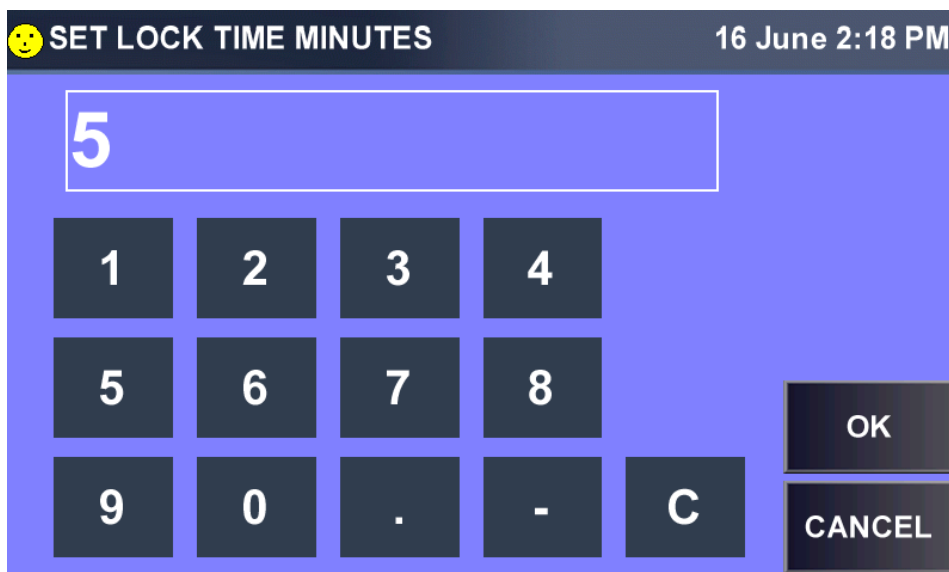

- ▶ When you return to the **GENERAL SETTINGS** screen, press the *RIGHT* arrow button to open the next **GENERAL SETTINGS** screen:



Operation

S41i CO₂ Incubator Shaker
English (EN)

In the previous example, the display is set to 24-hour (military) time. If you press the Format line, it will automatically toggle to 12-Hour:

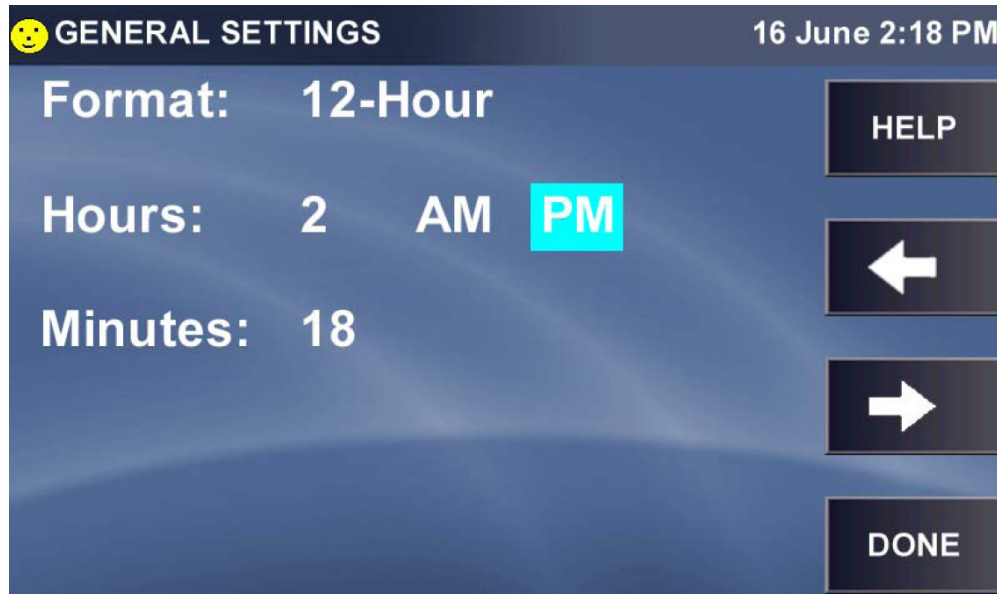

- ▶ To change from **PM** (highlighted) to **AM**, press **AM**.
- ▶ To change the Hours, press either Hours or the number (2 in this case) and use the popup keypad to update the hour, then press the *OK* button to save your update.
- ▶ To change the Minutes, press either Minutes or the number (18 in this case) and use the popup keypad to update the hour, then press the *OK* button to save your update.
- ▶ Press the *RIGHT* arrow button to open the next **GENERAL SETTINGS** screen:

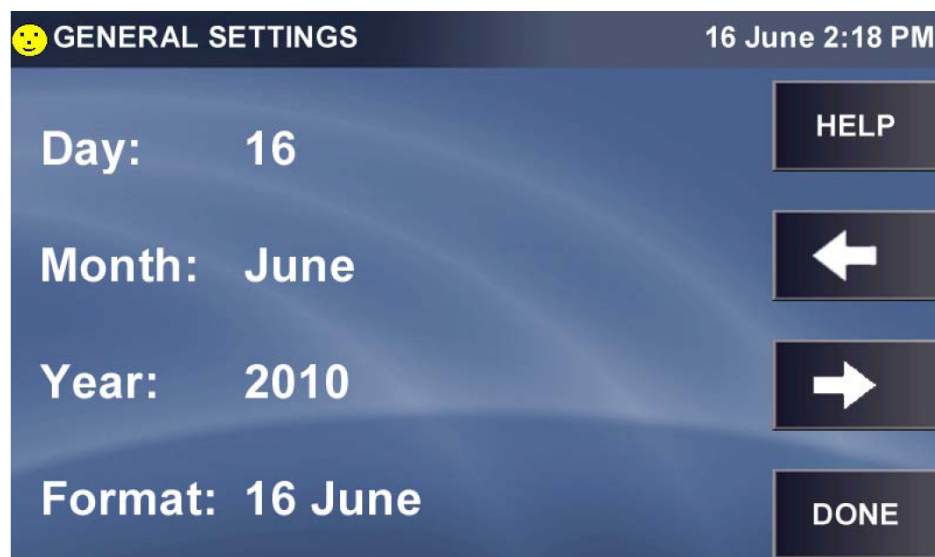

- ▶ Press **Day**, **Month** and/or **Year** and use the popup keypad in each case to correct the date, which is displayed in the upper righthand corner of the screen.
- ▶ To change the **Format** of the date (shown in European style), press anywhere in the Format line to open the **SET FORMAT** screen:

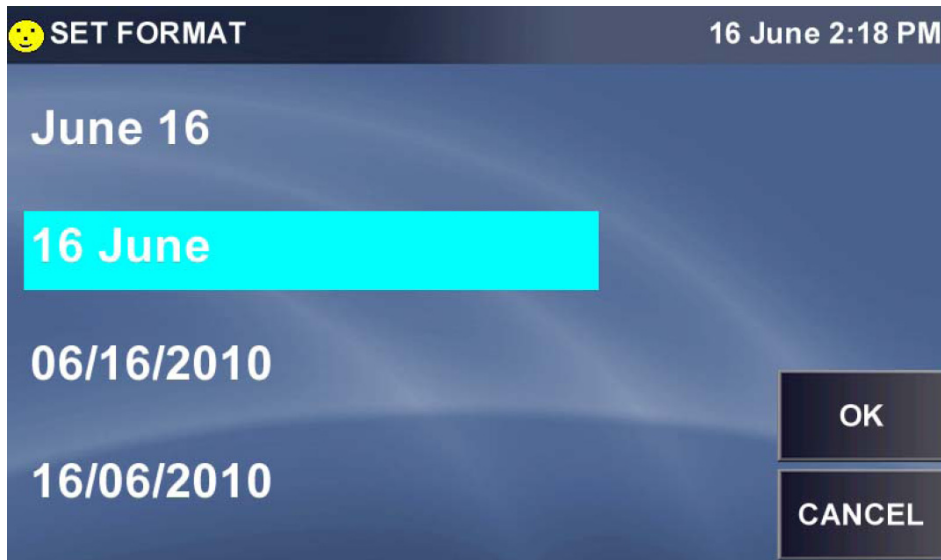

- ▶ Press the date format you prefer, for example June 16, then press the *OK* button to return to the date settings screen. Note that the date format in the top right corner has changed:



- ▶ After you have made all desired changes to the settings, press the *DONE* button to return to the **MENU**.

5.5.8 USER ACCESS screen

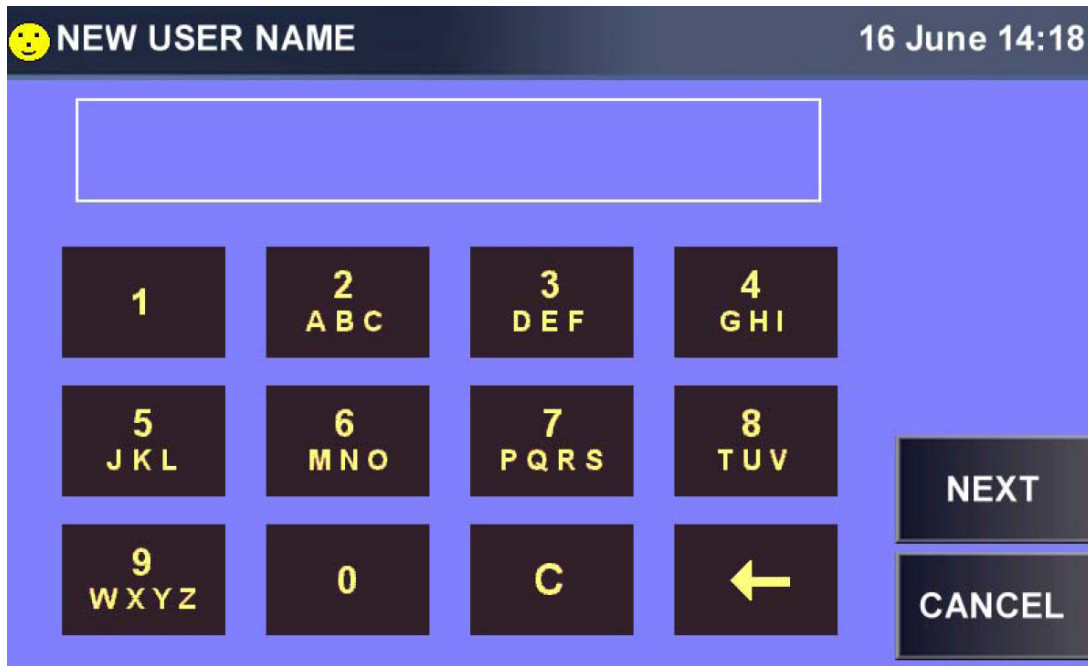

Fig. 5-7: Users button

- ▶ Press the *Users* button to open the **USER ACCESS** screen:



▶ Press the *NEW* button to add a User. In the **NEW USER NAME** keypad:



- ▶ Use the keypad to choose numbers and/or letters. For buttons with one number and several letters, you will need to press repeatedly to input the desired character (they appear in sequence; for example, press 2, *ABC* button once to display 2 in the edit field; a second time to display A; press it again for B; and a fourth time for C. If you press it again, it will cycle back to 2.
- ▶ Move to the next key to input the next number or letter.

i A user name may be up to 8 characters in length.
If you need two or more items from the same key, wait a few seconds after selecting the first, then press the key again as needed to select the next item.

In this sample screen, we pressed the 3, *DEF* key three times to cycle through 3, then D, to E:



Operation

S41i CO₂ Incubator Shaker
English (EN)

- ▶ When the **User Name** is complete, press the *NEXT* button. The name will be saved, and the **NEW PASSWORD** keypad will open:

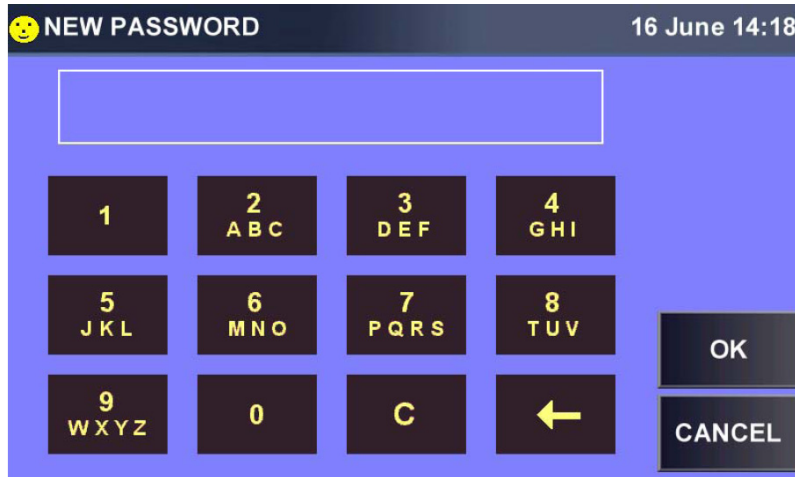

The keys work the same way here as in the **NEW USER NAME** screen.

- ▶ When the desired Password is in the field, press the *OK* button to save it for the new user and to return to the **USER ACCESS** screen.
- ▶ If the Password is inappropriate (for example, too short), you will be prompted with an **ILLEGAL PASSWORD** warning screen:

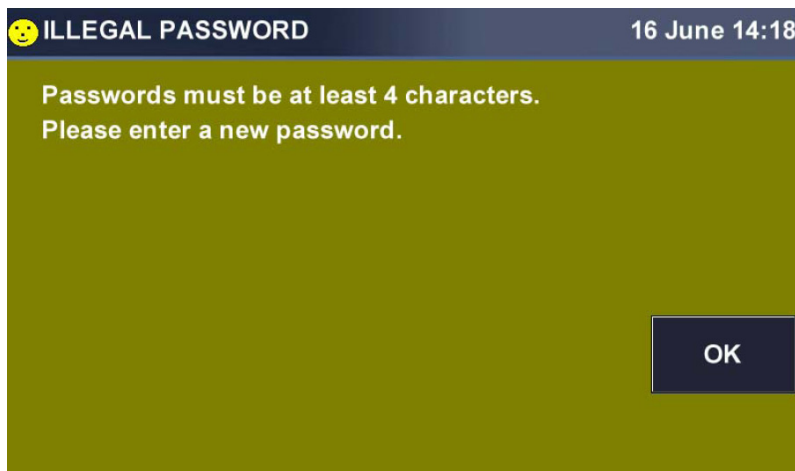

- ▶ Press the *OK* button to return to the **NEW PASSWORD** keypad and input an appropriate password.
- ▶ When the desired Password is in the field, press the *OK* button to save it for the new user and to return to the **USER ACCESS** screen.

You may need to set privileges for one or more users:

- ▶ Press the user's name to highlight that row, then press the *EDIT* button to open the EDIT USER screen:

EDIT USER 16 June 14:18

Name: MATT HELP

Password: *****

Setpoint Access: YES NO

Admin Access: YES NO

OK

CANCEL

- ▶ Press Name: to open the **CHANGE USER NAME** screen, make changes, then press the *OK* button to return to the **USER ACCESS** screen.
- ▶ To make more edits to this or any other user's information, press the user's name to highlight the row, then press the *EDIT* button.
- ▶ **PASSWORD** screen; press the YES or NO for **Setpoint Access** and/or **Admin Access** to select the desired settings, then press the *OK* button to return to the **USER ACCESS** screen.



Setpoint Access gives the user access to edit setpoints.
Admin Access allows access to all user functions.

To remove a user from the system:

- ▶ Highlight the name, press the *DELETE* button, then press the *OK* button. You will be prompted to indicate whether you are sure about this deletion:

DELETE USER 16 June 14:18

Are you sure you want to permanently remove user C3PO ?

YES

NO

- ▶ Press the *YES* or *NO* button as appropriate. You will return to the **USER ACCESS** screen.
- ▶ Press the *DONE* button when you have finished to return to the **MENU** screen.

5.5.9 COMMUNICATIONS screen



Fig. 5-8: Communications button

- ▶ Press *Communications* button to open the **SET COMMUNICATIONS** screen:

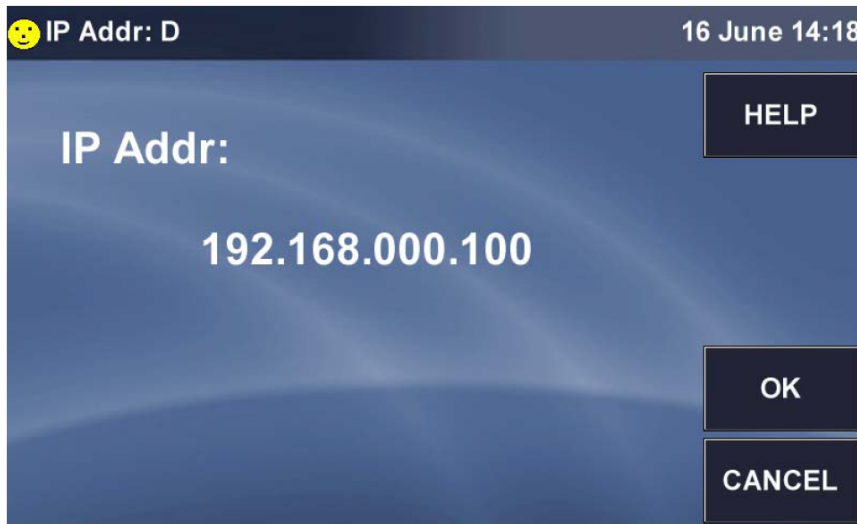

Ethernet is the default mode, which is why the IP Address is displayed.

If you need to change the IP address

- ▶ press that line to open a keypad for the first three digits:

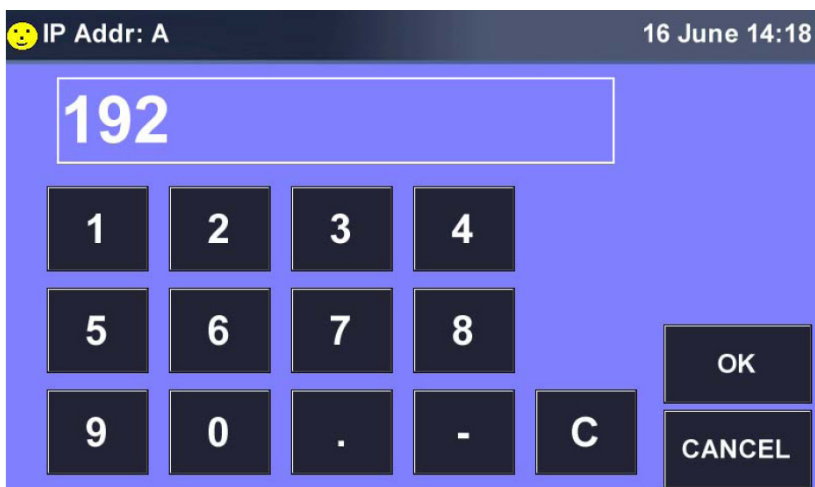

- ▶ Use the *OK* button either to reset each of the four sets of digits (Address A, B, C and D) or to cycle through each set and change any as needed.
- ▶ Press the button in the **SET COMMUNICATIONS** screen at any time to return to the **MENU** screen.

5.6 MENU 2 Screen

- ▶ To open the **MENU 2** screen, press the *RIGHT* arrow button in the **MENU 1** screen:



If any option shown above is not present on your system, the button will not appear in your **MENU 2** screen.

5.6.1 SERVICE screen



Fig. 5-9: Service button

Use of the *SERVICE* button and the Service screen it represents is reserved for authorized service technicians and therefore requires a Passcode. You will not have (or need) access to this screen.

5.6.2 DIAGNOSTICS screen



Fig. 5-10: Diagnostics button

Operation

S41i CO₂ Incubator Shaker
English (EN)



The only time you will need to consult this screen is during a conversation with your authorized service technician, who may ask you to report information from the system's diagnostics.

- ▶ Press the *Diagnostics* button to open the 1st page of the **DIAGNOSTICS** screen:



Note that the title of the screen indicates that there are 11 pages to this screen.

Press the *RIGHT* button to scroll through the next page(s) as needed.

When you have finished reviewing the screens, press the **DONE** button to return to the **MENU**.

5.6.3 MAINTENANCE screen

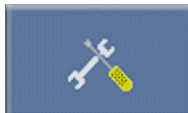

Fig. 5-11: Maintenance button



When connecting a USB device, the device must be a FAT32 file system. Filing systems such as NEST will not work properly.

Press the *Maintenance* button to open the *MAINTENANCE* screen:



5.6.3.1 Update Controller Firmware

Firmware updates are available on our website.

- ▶ If wish to **Update Controller Firmware**, press that line to select it:



Then press the *NEXT* button. You will be prompted with this screen:



- ▶ Do as instructed to download the update. The USB port is located under the display bezel.
- ▶ Press the *DONE* button to return to the **MAINTENANCE** screen.

If you have finished working in the **MAINTENANCE** screen, press the *DONE* button to return to the **MENU**.

5.6.3.2 Update Display Firmware

Firmware updates are available on our website.

- ▶ If you wish to **Update Display Firmware**, press that line to select it:



- ▶ Then press the *NEXT* button; you will be prompted with this screen:



- ▶ Do as instructed to upload the User Interface binary update files. The USB port is located under the display bezel.
- ▶ Press the *DONE* button to return to the *MAINTENANCE* screen.

When you have finished working in the **MAINTENANCE** screen, press the button to return to the **MENU**.

5.6.3.3 View sensor trends

The **View Sensor Trends** screens display up to 72 hours of data. If a problem should occur in operation, your authorized service technician may ask you to access data from one or more of the sensors, to export it via USB drive and to send the file to Eppendorf for evaluation. This section will explain how to access, export and, when appropriate, clear this data.

- ▶ If you are prompted by your authorized service technician to *View Sensor Trends* in the **MAINTENANCE** screen, press this line to select it:

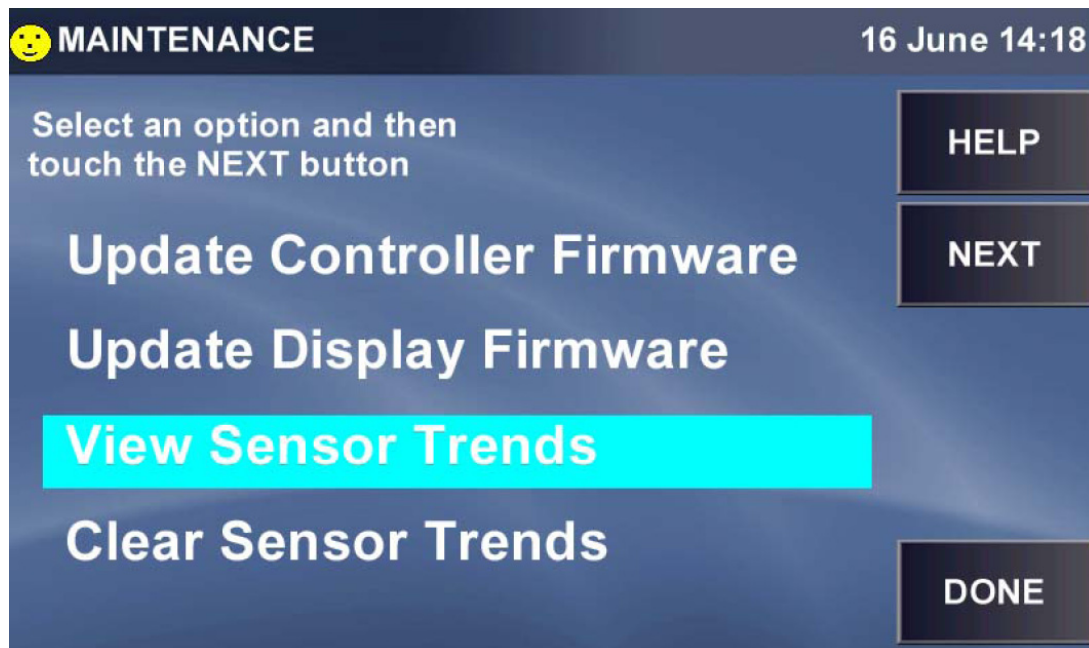

- ▶ Press the *NEXT* button to open the first of five *DIAGNOSTIC TRENDS* screen:



These sample screens do not display any logged data, but your screens should be complete with data.

Take special note of the color of each sensor parameter at the top of the screen, to identify its related trend on the graph.

- ▶ If the desired information is not displayed here, press the *RIGHT* arrow button to scroll through the additional screens.
- ▶ At any time you can press the *LEFT* button to return to the previous screen.
- ▶ As with the Event Graph, at any time you can press the X or Y axis to change the display parameters of these trends.
- ▶ At any time you can press the *EXPORT* button to save diagnostic data to a USB memory stick/flash drive. You will be prompted with the following screen:

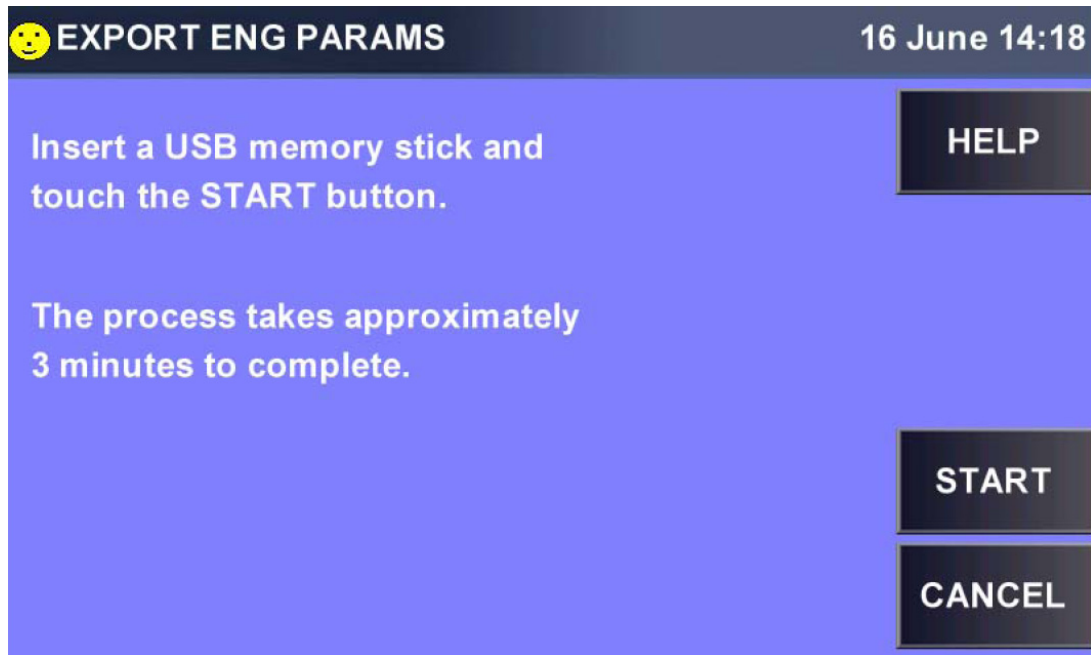

- ▶ Follow the instructions. When you press the *START* button, this screen will appear:

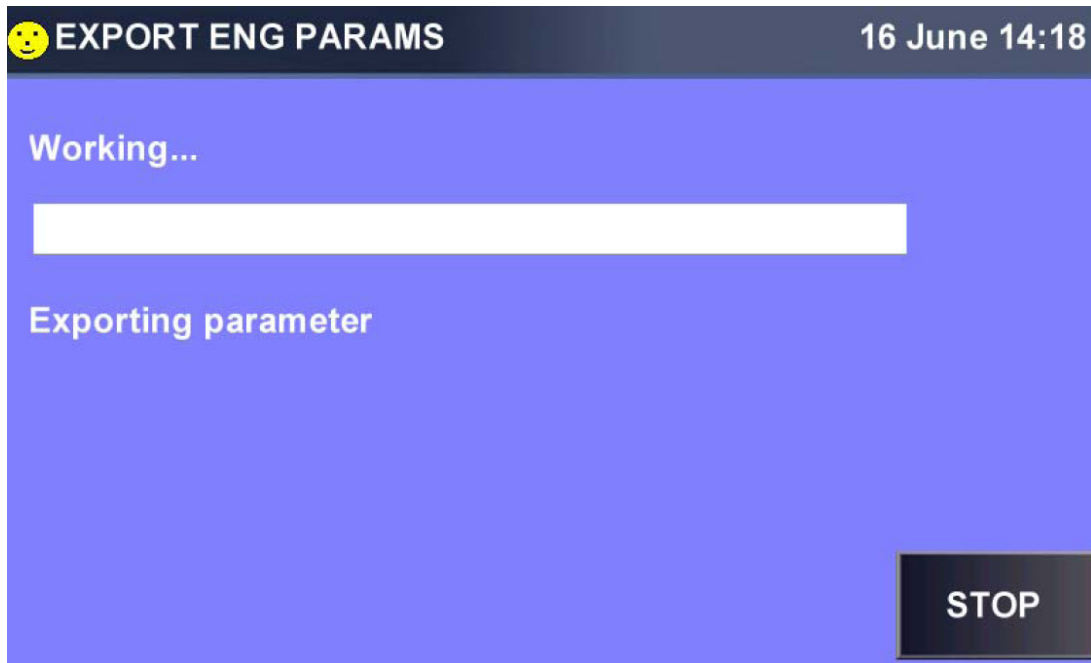

- ▶ When you have finished working in the **MAINTENANCE** screen, press the *DONE* button to return to the **MENU**.

5.6.3.4 Clear sensor trends

- ▶ If you wish to clear all the data logged in the diagnostic sensor trends screens, press **Clear Sensor Trends** to select it:



- ▶ Press the *NEXT* button and you will be prompted by this screen:

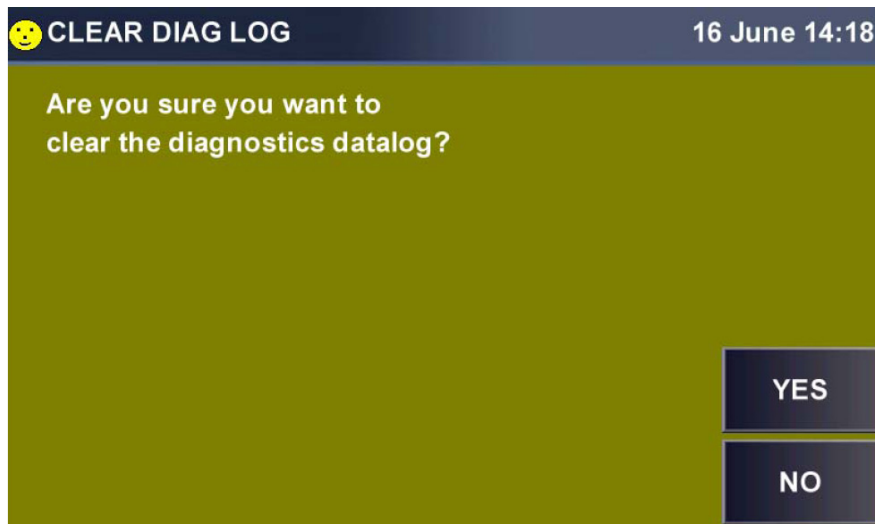

- ▶ Press the *YES* button to clear the data and return to the **MAINTENANCE** screen, or, if you change your mind, press the *NO* button to retain the data and return to **MAINTENANCE** screen.

Operation

S41i CO₂ Incubator Shaker
English (EN)

5.6.4 OPTIONS screen



Fig. 5-12: Options button

The **INSTALLED OPTIONS** screen indicates the options present in your incubator shaker, and allows you to make certain choices regarding their use.

- ▶ Press the *Options* button to open the **INSTALLED OPTIONS** screen:

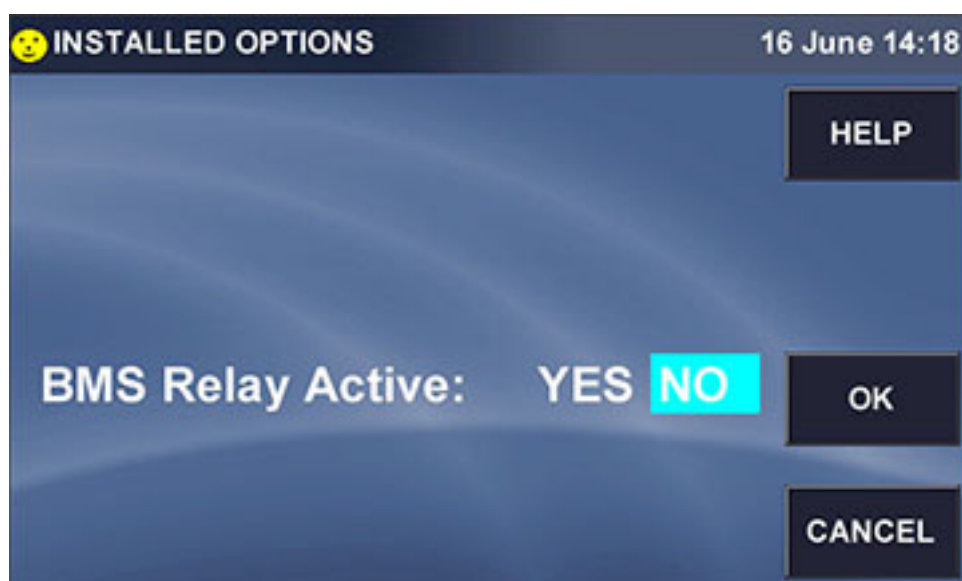

- ▶ If you have an **ON** and **OFF** choice for an option, press your selection, then press the *OK* button to enable that selection.
For details on the options shown in this sample screen, see (see *BMS relay contact alarm on p. 29*).
- ▶ Press the *OK* button to close this screen and return to the **MENU**.

5.6.5 SET CO₂ AUTOZERO screenFig. 5-13: CO₂ Autozero button

The CO₂ Auto-Zero feature tests the CO₂ sensor by pumping outside air (atmosphere) into the CO₂ sensor's measuring area, to displace the chamber air at that location. This process take only a few minutes. The sensor is re-referenced to the CO₂ level from the atmosphere before the chamber air mixes in with the atmosphere and normal CO₂ control resumes.

- ▶ Press the *CO2 Autozero* button to open the **SET CO2 AUTOZERO** screen:



- ▶ Press **Frequency** to reset the occurrence of CO2 Autozero: press once for Daily, a 2nd time for Weekly, press again for Bi-Weekly, a 4th time for Monthly, then back to OFF.
- ▶ Press **Start Time** to open this screen:

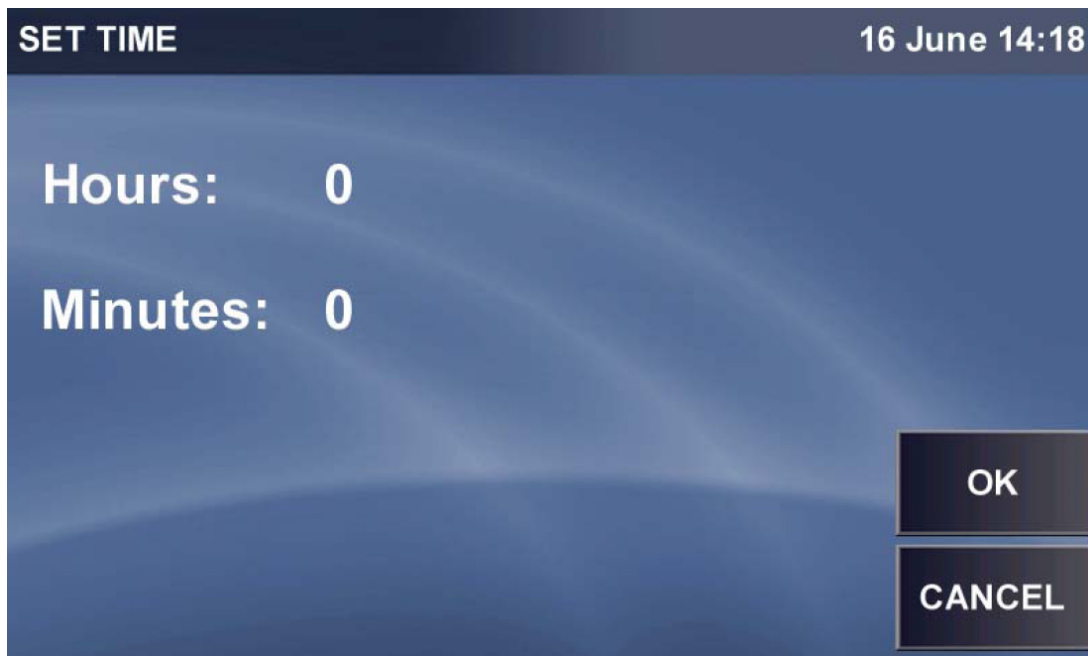

Operation

S41i CO₂ Incubator Shaker
English (EN)

- ▶ Press **Hours**, then use the **SET HOUR** keypad to enter the Hour time:

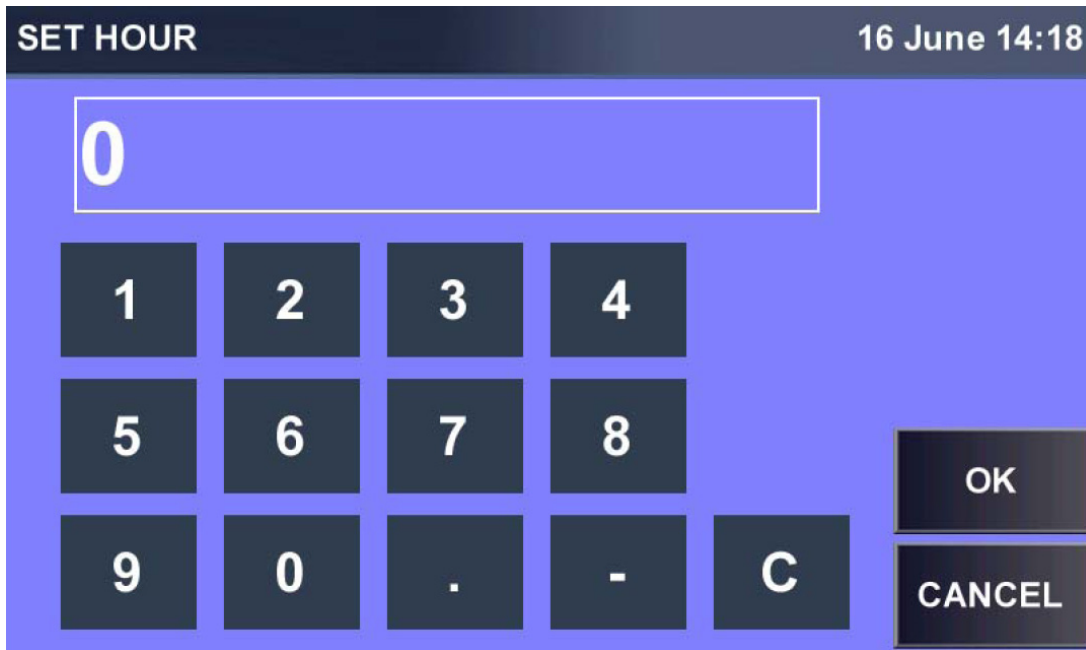

- ▶ Press the *OK* button to save your input; now do the same for the minutes.
- ▶ When your selections are made in the **SET TIME** screen, press the *OK* button to return to the **SET CO₂ AUTOZERO** screen.
- ▶ To start a CO₂ Autozero at this time, press the *RUN AZ* button. This screen will open:

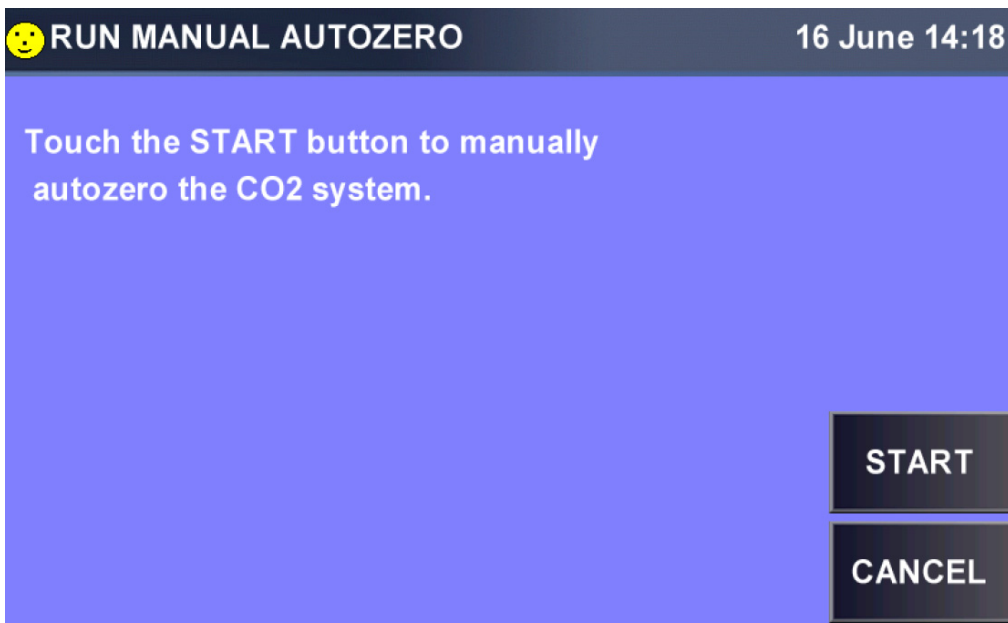

- ▶ Press the *START* button to confirm your wish to run the program. This is called a manual autozero because it is being initiated outside the automatic settings.

The autozero will begin, and this screen will track the progress of the procedure:

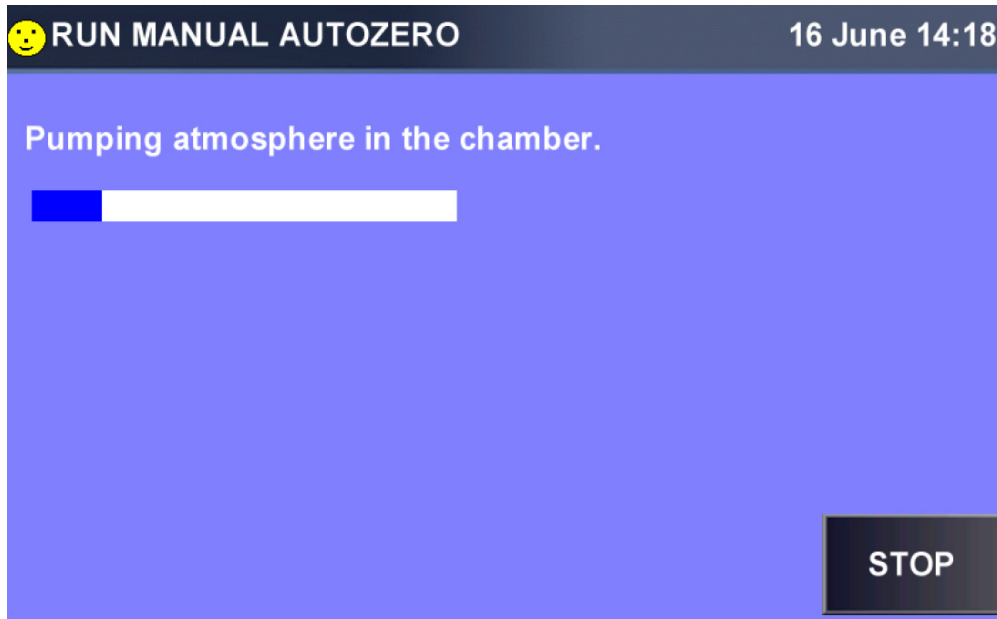

When the long white box is fully blue, indicating the atmosphere pumping has been completed, the screen will change to indicate "CO₂ Autozero is complete. Result: Completed OK."

- ▶ To abort the procedure at any time, press the *STOP* button.
If you do so, this screen will appear:

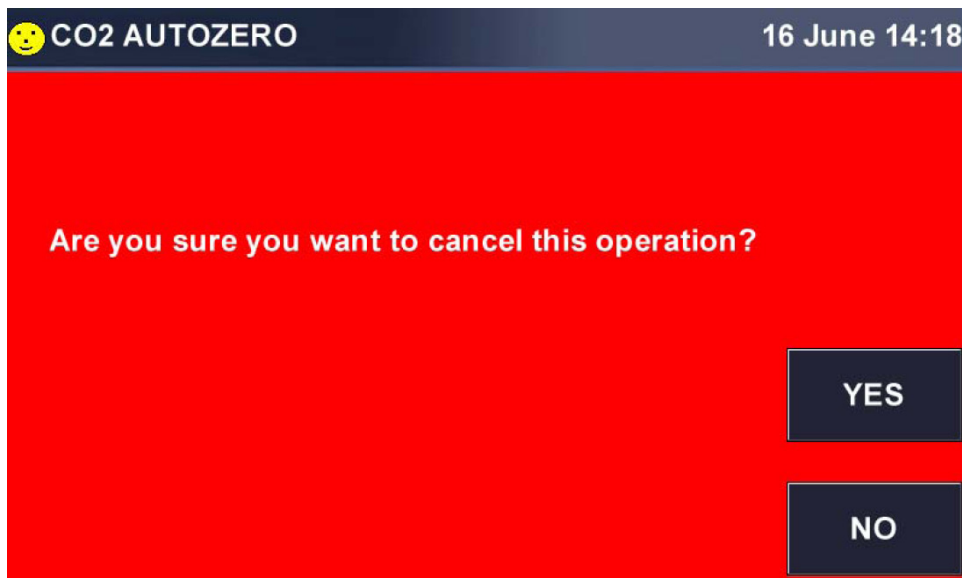

- ▶ To confirm that you wish to cancel the procedure, press the *YES* button. The following screen will appear:

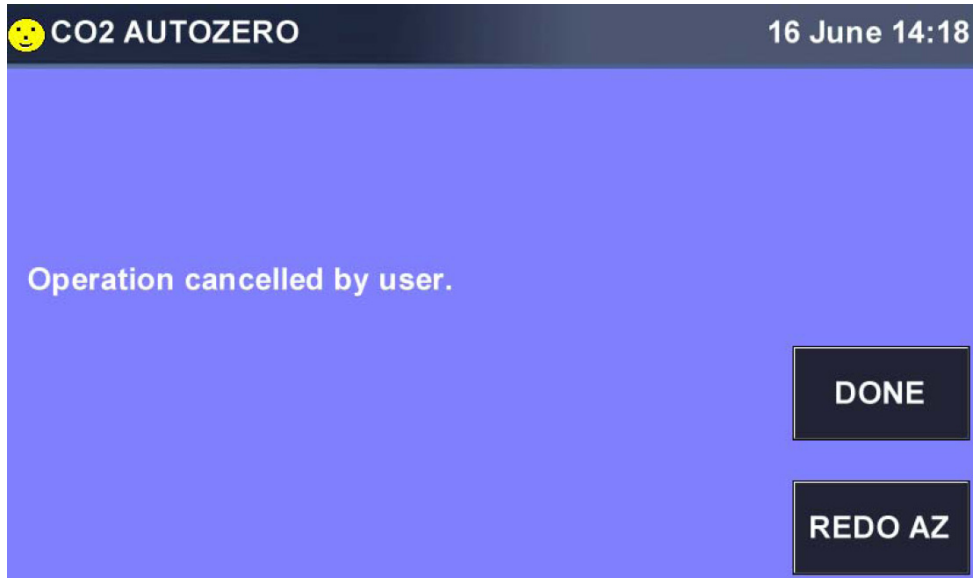

Your options are to press the *REDO* button to begin the procedure again or to press the **DONE** button to return to the **SET CO2 AUTOZERO** screen.

- ▶ Press the *OK* button to return to the **MENU**.

5.6.6 DISINFECTION screen

For more info on High Temperature Disinfection (see *High temperature disinfection on p. 15*).



Fig. 5-14: Disinfection button

- ▶ To run the High Temperature Disinfection program, press the *Disinfection* button.

► In the screen that opens:

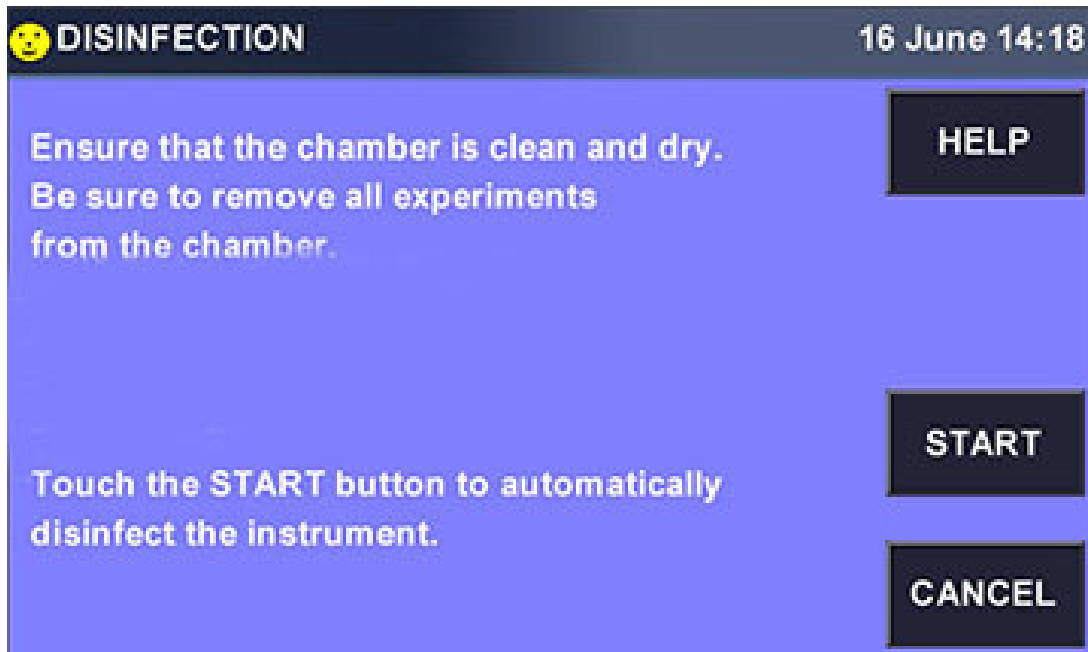

Follow the on-screen prompts. (Press the *CANCEL* button if you are not yet ready to disinfect, or if you decide not to proceed.)

If you press **START**, the following screen will chart the progress of the disinfection program:

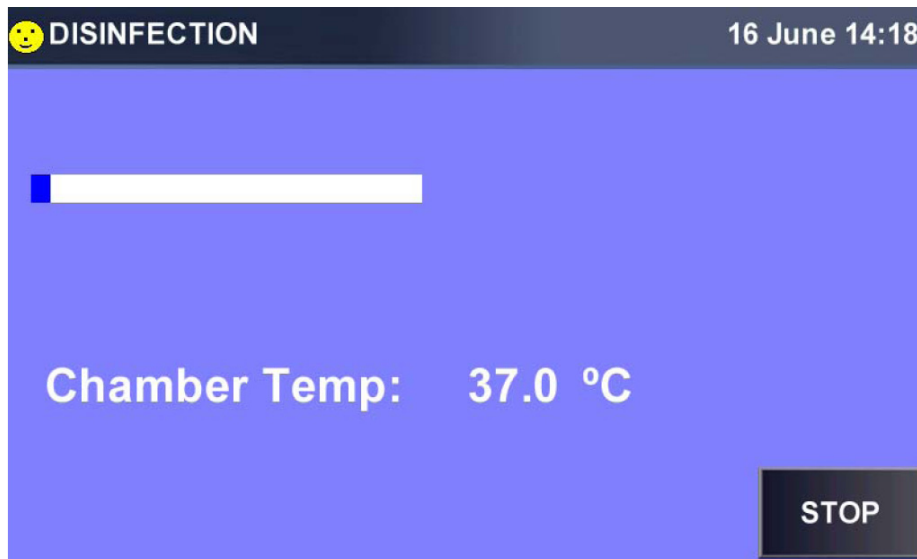

You can press the *STOP* button at any time to stop the program.

If the disinfection is aborted, you will see this screen:

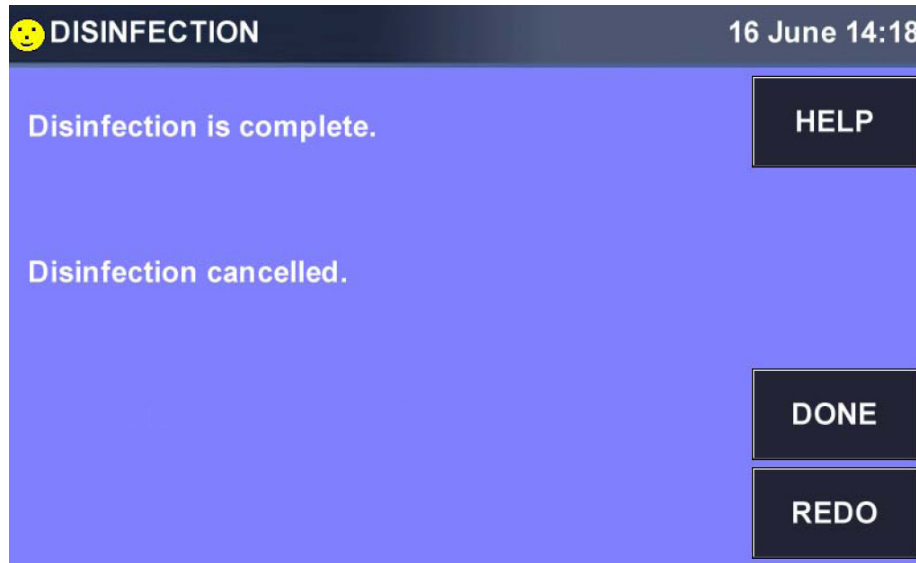

- ▶ To restart the program, press the *REDO* button.
- ▶ To acknowledge the process is complete, press the *DONE* button; you will return to the **MENU** screen.

5.7 Mains/Power Interruption and Fault Interruption

In the event of a mains/power failure, S41i incubator shakers are equipped with an **automatic restart** function. The incubator shaker's non-volatile memory retains all stored information.

If the incubator shaker was in operation prior to the mains/power interruption, the incubator shaker will begin to operate at its last entered setpoints. The smiling icon will be green to indicate automatic restart until you touch the screen; then it will turn yellow. The alarm display will flash, indicating that a mains/power interruption has occurred; you will need to acknowledge the alarm.

In the unlikely event of a mechanical shaking fault interruption, the S41i incubator shaker display will flash an alarm and warn the user with an audible signal, indicating an alarm has occurred. In this mechanical shaking fault interruption, the shaker **will not restart** the shaking function.

The incubator shaker will not operate shaking until the alarm is muted, acknowledged, and shaking is manually restarted from the touch screen at the last entered setpoints.

6 Maintenance

6.1 Routine Maintenance

6.1.1 General notes

To ensure that chamber conditions remain as stable as possible, be sure to minimize the length of time that the door is open. When you open the door, wipe off any small drops of condensate that may have formed on the inner seal. This will avoid a build-up of condensation.

If you are using the humidity tray for humidification, be sure to follow the indications provided (see *Electrical Connections on p. 24*) and (see *Using the Humidity Trays on p. 31*).



There is no need to remove the top panel for normal maintenance or servicing, so if you have two incubator shakers stacked, the upper incubator shaker does not have to be moved when you are servicing the lower incubator shaker.

6.1.2 Daily checks

1. Check that the temperature and CO₂ levels are reading within specification.
2. Check that gas supply lines have inline regulators, that they are properly installed and functioning.
3. Check the reserve pressure in the CO₂ cylinder (normally 725 psi or 50 bar when full). The design of the incubator shaker ensures very low consumption of CO₂: during normal working conditions, a typical large cylinder should last approximately 12 months (frequent door openings will deplete the supply more rapidly). If there is a significant drop at the cylinder pressure of 725 psi or 50 bar, it means that the cylinder is almost empty and should be replaced. Ensuring that there are no leaks at any of the connections will ensure a greater lifetime to the CO₂ supply and will help avoid accidentally running out of CO₂.
4. Check the **ALARM** and **EVENT LOG** screens for any alarms or events that may have occurred overnight.

6.1.3 Weekly checks

- ▶ If you are using them for humidification, check the humidity trays and refill them as needed. Be careful not to exceed the maximum volume of 250 mL per pan. The use of warm water (~ 37.0 °C) will ensure a rapid return to optimum chamber conditions.

6.1.4 Monthly check

- ▶ Auto-Zero the CO₂ system at least once monthly to ensure that the CO₂ level is correct.
- ▶ We recommend monthly replacement of the water in the humidity trays. Clean the trays at the same time.
- ▶ If required, you can take a sample of the gas inside the chamber using the CO₂ sample port, and check it using a CO₂ gas analyzer (see *CO₂ Sampling with Analyzer on p. 76*).

6.1.5 Other checks

- ▶ At least once every six months, check tubing for wear and for leaks. Replace as needed.

Maintenance

S41i CO₂ Incubator Shaker
English (EN)

6.1.6 CO₂ Sampling with Analyzer

We recommend that you perform a CO₂ Auto-Zero prior to sampling.

The CO₂ sample port is located on the righthand side of the incubator shaker, near the top.

If you conduct a sampling, please ensure the following:

- ▶ Turn off the CO₂ gas by re-programming the setpoint for CO₂ to 0.0 % to prevent CO₂ from being injected into the chamber and giving a false reading.
- ▶ A flow rate ≤ 0.5 liters/minute is used to take a sample.
- ▶ The door is kept closed to minimize heat loss.
- ▶ Remember to reset the CO₂ setpoint to the desired level after sampling.

We also recommend that you Auto-Zero the CO₂ system at least once every month to ensure that CO₂ level is correct (see *Monthly check on p. 75*).

6.2 Cleaning

1. Routinely clean the exterior of the incubator shaker by wiping it over with a soft cloth, moistened with soapy water.
2. Rinse the soap from the cloth in clean water, and wipe the exterior surfaces again.

6.3 Disinfection/Decontamination

The recommended disinfecting agent for use with the incubator shaker is a solution of 70 % isopropanol (isopropyl alcohol) and 30 % distilled water.

Be sure to follow appropriate safety regulations while you are using this solution. To best protect yourself, your incubator shaker and your work area, follow these instructions:

**CAUTION! Risk of potential harm to personnel**

- ▶ As a routine precaution, wear protective gloves.
- ▶ Be sure to adequately ventilate the work area as you disinfect, to avoid the formation of potentially explosive alcohol vapors.

**NOTICE! Risk of material damage**

- ▶ Protect all electrical connections from contact with the alcohol solution.
-

1. Program 0.0 % CO₂ and switch off the incubator shaker. Unplug the incubator shaker from the mains/ power supply.
2. Dampen a clean cloth with the alcohol solution and wipe down all external surfaces, taking care to keep the alcohol solution from coming into contact with any electrical outlets or assemblies.
3. Remove all of the shelves, the humidity trays and the removable shelf racks.



NOTICE! Risk of equipment damage

- ▶ Ensure that no liquid is spilled onto the white porous CO₂ sensor cover.
- ▶ Failure to use the protective cover(s) could result in damage to the sensor(s) and may affect your warranty.

4. Place the black protective cover over the CO₂ sensor. Also protect any additional sensors, such as Oxygen or Humidity, with the cover(s) supplied.
5. You can clean the humidity trays by rinsing them in sterile water, wiping them down with the alcohol solution, and then rinsing them again with sterile water.



NOTICE! Risk of equipment damage and/or hazard

- ▶ Never use any of the following substances to clean the stainless steel, otherwise damage and/or hazard will result: Sodium Azide, Aqua Regia, Iodine, Ferric Chloride or Sulphuric Acid.



CAUTION! Risk of potential harm to personnel

- ▶ If hazardous material is spilt onto or into the equipment, appropriate decontamination procedures and safety practices must be employed.

6. Wipe down the inside of the chamber with the alcohol/water solution, and leave it to dry completely.
7. Wipe the internal components of the chamber twice with the alcohol/water solution. Wipe off excess liquid and leave it to dry completely.
8. Wipe the inner door seal with the alcohol solution, rinse and leave it to dry.
 -  As you remove the black CO₂ sensor cover, be very careful not to accidentally remove the white porous sensor cover; this must remain in place.
9. Ensure the protective cover(s) are removed from all sensor(s) and replaced in the holder for safekeeping.
10. Refill the humidity trays (see *Using the Humidity Trays on p. 31*). When you reinstall them, ensure that the trays are pushed fully back.
11. Leave the incubator shaker on overnight to allow conditions to stabilize.
12. When the incubator shaker has stabilized, carry out an Auto-Zero and reprogram the desired CO₂ level. It may be necessary to open the glass door briefly if, after performing an Auto-Zero, the CO₂ level is too high.
13. Always consult your sales representative or contact Eppendorf if there is any doubt about the compatibility of decontamination or cleaning agents with parts of the equipment or with material contained in it.

Maintenance

S41i CO₂ Incubator Shaker

English (EN)

7 Transport, storage and disposal

7.1 Disposal

In case the product is to be disposed of, the relevant legal regulations are to be observed.

Information on the disposal of electrical and electronic devices in the European Community:

Within the European Community, the disposal of electrical devices is regulated by national regulations based on EU Directive 2002/96/EC pertaining to waste electrical and electronic equipment (WEEE).

According to these regulations, any devices supplied after August 13, 2005, in the business-to-business sphere, to which this product is assigned, may no longer be disposed of in municipal or domestic waste. To document this, they have been marked with the following identification:



Because disposal regulations may differ from one country to another within the EU, please contact your supplier if necessary.

In Germany, this is mandatory from March 23, 2006. From this date, the manufacturer has to offer a suitable method of return for all devices supplied after August 13, 2005. For all devices supplied before August 13, 2005, the last user is responsible for the correct disposal.

8 Technical data

8.1 Weight/dimensions

8.1.1 Device Dimensions

Height (External)	848 mm (33.4 in)
Width (External)	834 mm (32.8 in)
Depth (External)	730 mm (28.7 in)
Height (External, crated)	1130 mm (44.5 in)
Width (External, crated)	1040 mm (40.9 in)
Depth (External, crated)	920 mm (36.2 in), pallet included
Weight (crated)	192 kg (423 lb)
Weight (uncrated)	152 kg (335 lb), with standard features

8.1.2 Platform dimensions

Width	612 mm (24 in)
Depth	356 mm (14 in)

8.2 Application Parameters

8.2.1 Speed

Speed (with 2.54 cm (1 in) orbit)	25 rpm – 400 rpm
Speed (with two incubator shakers stacked)	25 rpm – 250 rpm
Control accuracy	± 1 % full scale

8.2.2 CO₂ Management

Control range	0.2 % – 20 %
Accuracy	± 0.1 %
Stability	± 0.2 % at 5 % CO ₂
Uniformity	± 0.1 % at 37 °C
Recommended gas pressure	7 PSI / 0.5 bar

Technical data

S41i CO₂ Incubator Shaker
English (EN)

8.2.3 Temperature

Range	4 °C above ambient temperature to 50 °C
Accuracy	± 0.2 °C
Stability	± 0.1 °C at 37 °C
Uniformity	± 0.6 °C at ambient 20 °C – 25 °C
Uniformity in flask media	± 0.25 °C
Storage temperature	10 °C – 50 °C

8.2.4 Passive humidity

Provided by evaporation of distilled water placed in 2 stainless steel trays at the bottom of the chamber.

8.2.5 Altitude limit

Altitude limit	2000 m (2187.23 yd)
----------------	---------------------

8.3 Power supply

120 V, 60 Hz	1800 VA
230 V, 50 Hz	1800 VA
Energy to maintain 37 °C	< 0.2 kWh

9 Ordering information

9.1 Accessories

Description	Part number
Stacking kit	P0628-6502

Tab. 9-1: Incubation accessories

Description	Part number
Additional perforated shelf	P0628-6181
Two Stage CO ₂ Regulator	P0628-5010
In-line Hepa Filter	P0628-5020
Hepa Filter 25 mm	P0628-5060
CO ₂ Analyzer	P0628-6150
Temperature probe 5 mm tip	P0628-7881
Temperature probe 100 mm tip	P0628-7880
CO ₂ Changeover Unit	P0628-5000
Shelf Rack (pk of 2)	P0628-6182
S41i Humidity Tray	P0628-6200

Tab. 9-2: Shaker accessories

Description	Part number
Inter changeable platforms, 612 x 356 mm (24 x 14 in)	
Universal platform	M1334-9920
125 ml Dedicated platform	M1334-9921
250 ml Dedicated platform	M1334-9922
500 ml Dedicated platform	M1334-9923
1 L Dedicated platform	M1334-9924
2 L Dedicated platform	M1334-9925
2.8 L Dedicated platform	M1334-9926
4 L Dedicated platform	M1334-9927



When one shelf is installed, the largest flasks that can be contained in this incubator shaker are 1 L Erlenmeyer and 2.8 L Fernbach flasks. Without a shelf, Erlenmeyer flasks up to 4 L can be contained.

Ordering informationS41i CO₂ Incubator Shaker

English (EN)

Tab. 9-3: Platform accessories

Description	Part number	Dimensions (cm)
Sticky Tape	M1250-9600	Length: 1058 cm (416.6 in) Width: 4 cm (1.6 cm)
Sticky Pad Adapter Kit	M1250-9904	46 x 15.25 cm 2 Pieces (18 x 6 in)
Microplate rack (stack)	M1289-0700	H x W x D 13.1 x 9.0 x 18.0 cm (5.16 x 3.54 x 7.09 in)
Microplate rack (1 layer)	TTR-221	45.7 x 13.5 cm (18 x 5.31 in)

Tab. 9-4: Flask clamps

Clamp size	Part number	Dedicated Platform Capacity	Universal Platform Capacity
10 mL Erlenmeyer	ACE-10S	-	-
25 mL Erlenmeyer	M1190-9004	-	-
50 mL Erlenmeyer	M1190-9000	-	-
125 mL Erlenmeyer	M1190-9001	32	20
250 mL Erlenmeyer	M1190-9002	24	16
500 mL Erlenmeyer	M1190-9003	15	12
1 L Erlenmeyer	ACE-1000S	11	10
2 L Erlenmeyer	ACE-2000S	6	4
2 L Lauber Thompson	M1190-9005	-	4
2.8 L Fernbach	ACFE-2800S	3	3
3 L Erlenmeyer	ACE-3000S	-	3
4 L Erlenmeyer	ACE-4000S	3	3
500 mL Media Bottle	ACSB-500S	-	-
1 L Media Bottle	ACSB-1000S	-	-

Tab. 9-5: Test Tube Racks

Rack Size	Part number	Test Tube Diameter	Tubes/Rack	Test Tube Rack Capacity
Small	M1289-0001	8-11 mm	48	6
	M1289-0002	12-15 mm	34	
	M1289-0003	15-18 mm	24	
	M1289-0004	18-21 mm	18	
	M1289-0005	22-26 mm	13	
	M1289-0006	26-30 mm	12	
Medium	M1289-0010	8-11 mm	60	3
	M1289-0020	12-15 mm	44	
	M1289-0030	15-18 mm	31	
	M1289-0040	18-21 mm	23	
	M1289-0050	22-26 mm	16	
	M1289-0060	26-30 mm	16	
Large	M1289-00100	8-11 mm	80	3
	M1289-00200	12-15 mm	60	
	M1289-0300	15-18 mm	42	
	M1289-0400	18-21 mm	30	
	M1289-0500	22-26 mm	22	
	M1289-0600	26-30 mm	20	

Test tube diameter	Tubes (mL)
15 - 18 mm (0.59 - 0.71 in)	15 mL conical tube "Falcon" 5 mL Eppendorf tube
26 - 30 mm (1.02 - 1.18 in)	50 mL conical tube "Falcon"
8 - 11 mm (0.31 - 0.43 in)	1.5 mL Eppendorf safe-lock tube

Index

S41i CO₂ Incubator Shaker
English (EN)

Index**A**

ATEX Guideline9

B

BMS relay contact alarm29

C

Caution, explanation of7

CO₂ control81

Copyright.....2

D

Danger, explanation of7

Dimensions.....81

Disposal79

F

Flask clamp.....22

H

Hazard symbols7

High Temperature Disinfection 15

HTD 15

Humidity trays31

M

Mains82

Mains/power supply82

Manual conventions8

N

Notice, explanation of7

O

Operation speed..... 81

P

Power supply 82

Pressure, Recommended 81

Product liability..... 10

R

Recommended gas pressure 81

Requirements, utilities..... 18

S

Stacking incubator shakers 19

Staking shakers..... 24

Symbols used..... 8

T

Trademarks 2

U

Using this manual 7

Utilities requirements 18

W

Warning, explanation of 7

Weight..... 81

Declaration of Conformity

The product named below fulfills the requirements of directives and standards listed. In the case of unauthorized modifications to the product or an unintended use this declaration becomes invalid.

Product name:

New Brunswick™ S41 i

including accessories

Product type:

CO₂ Incubator / Shaker

Relevant directives / standards:

2006/95/EC: EN 61010- 1, EN 61010- 2- 010, EN 61010- 2- 051, UL 61010- 1,

CSA C22.2 No. 61010- 1, CSA C22.2 No. 61010- 2- 010, CSA C22.2 No. 61010- 2- 051

2004/108/EC: EN 55011, EN 61326- 1,

CISPR 11, FCC 47CFR Part 15 Subpart B

2011/65/EU

Date: April 13, 2015



Management Board



Portfolio Management

Your local distributor: www.eppendorf.com/contact
Eppendorf AG · 22331 Hamburg · Germany
eppendorf@eppendorf.com

Eppendorf® and the Eppendorf logo are registered trademarks of Eppendorf AG, Germany.
U.S. Design Patents are listed on www.eppendorf.com/ip.
All rights reserved, incl. graphics and pictures. Copyright 2015 © by Eppendorf AG.

www.eppendorf.com

ISO 9001
Certified

ISO 13485
Certified

ISO 14001
Certified

Evaluate Your Manual

Give us your feedback.
www.eppendorf.com/manualfeedback